



■ Control Solutions

LOCC-Box LUTZE Overload Current Control

Intelligent DC Control Circuit Protection

Efficiency in Automation

Cable • Connectivity • Cabinet • Control

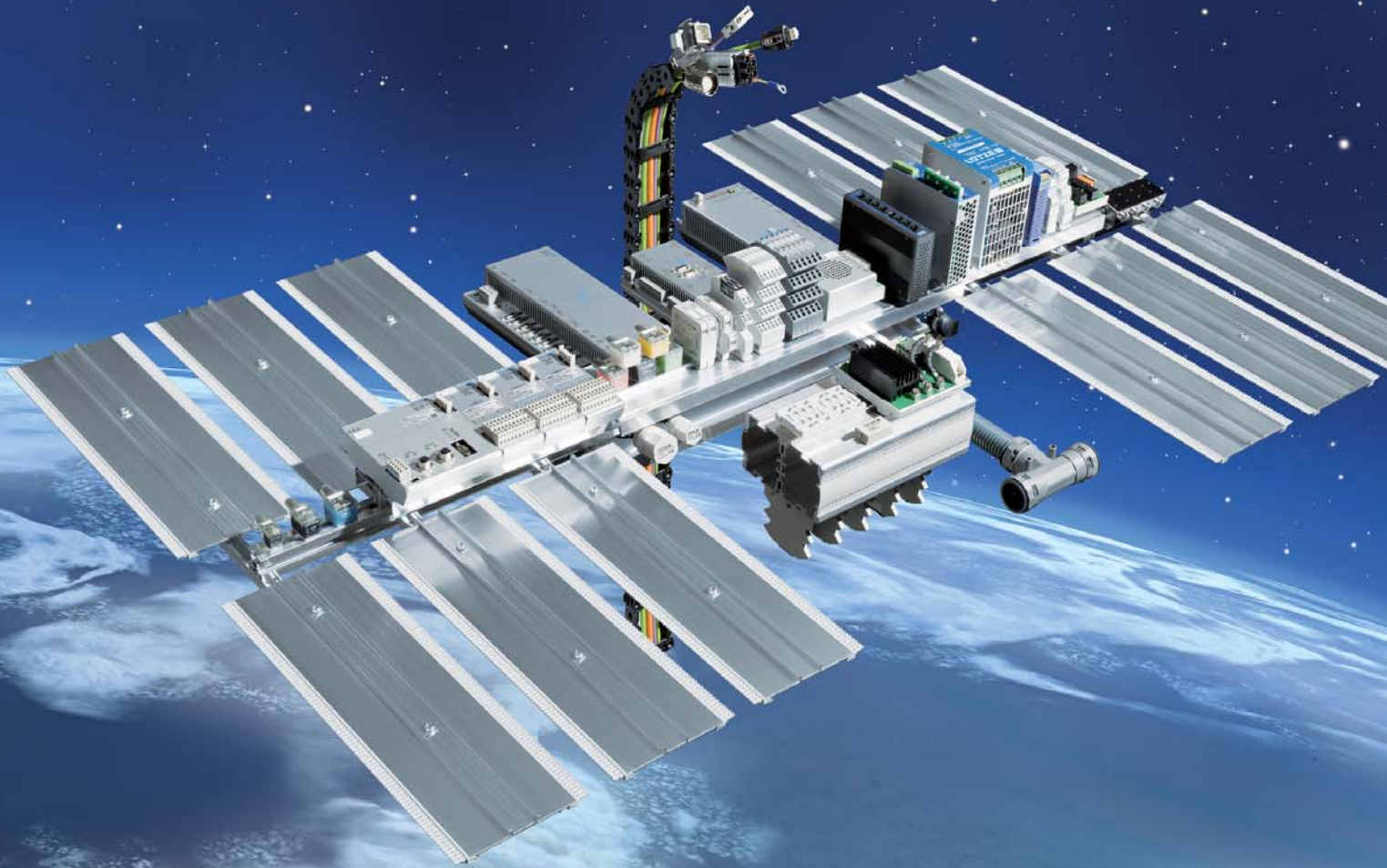

Welcome to LUTZE

Cable Solutions



Efficiency in Automation - A reflection of our company philosophy

As an experienced specialist in automation technology, with solutions for flexible and high flexing cables, cable assemblies, interfaces, current control and cabinet wiring, we have had a focus on efficiency for many years.

Connectivity Solutions



LUTZE defines Efficiency in Automation field as the use of sustainable products and solutions to further increase the performance of our products in our customers applications.

We realise this by using components for highly efficient control systems, products with above average life cycles and raising energy efficiency in control cabinets by means of the LSC wiring system.

Cabinet Solutions



Efficiency in Automation reflects our efforts in striving for efficient working relationships with our customers: in a medium sized family owned company we have short communication channels and a high level of manufacturing competence.

The value of a product or a solution from LUTZE is determined by its sustainable qualities. Every innovation will only be successful in the future if it has a long term positive effect. Therefore, we provide long lasting as well as highly efficient components.

Control Solutions



Thus LUTZE creates value through efficiency. LUTZE provides answers and demonstrates how to handle resources responsibly, with our environment and our future in mind. **LUTZE - Efficiency in Automation**

For more information on our solutions, please visit www.lutze.com

Transportation Solutions





Business Management: Sustainable and forw



The future is blue

Sustainable enterprise means thinking and planning ahead, understanding and embedding the belief that long lasting success is more important than short-term profit maximisation.

This is an attitude that has existed within LÜTZE for quite some time. Economic and environmental responsibilities complement each other well and are reflected in the sustainable management and

product policy - and from now in the **SkyBLUE** campaign.

We manufacture our products in a resourceful and energy-conscious manner. We use long lasting, environmentally-friendly materials.

And our products, in turn, help our customers save energy and resources.

Good for everyone: for us, for the environment, for our customers a win-win-win situation.

ard-looking

„The competitiveness of our industry and of its suppliers depends quite substantially on how we succeed in developing practical results. The results that we produce together today, are our competitive advantages in the future.“

*Udo Lütze,
Member of the Executive Committee of
the Green Carbody Innovation Alliance*



Goods with real value

The value of a product or a solution from LÜTZE is determined by its sustainable qualities as well. Every innovation is only as successful in the future if it has a long-term positive effect. Therefore, we provide long lasting as well as highly efficient components.

We are incorporating the necessary knowledge and manufacturing competence in numerous joint projects with the objective of improving energy efficiency and

sustainable technologies and industries. Thus, LÜTZE provides answers and demonstrates how to handle resources responsibly, with our environment and our future in mind.



RoHS

Current Control System · Basics

Reliable protection of DC 24V circuits

Intelligent safeguarding of selectivity

Primary switching controllers and automatic power units nowadays form the basis of the DC 24V supply level. Due to the operating behaviour of those devices, the specified selective protection of individual circuits, especially in case of overcurrent, is virtually unfeasible. A complete system shutdown is inevitable.

Operating behaviour of primary switching controllers

Switched-mode power supplies and their components are rated for a specific nominal value and run hot under higher load. To protect against self-destructing, they shut down at between 1.1 and 2.5 times the nominal current, according to type. Many devices feature Hiccup mode, which switches off in case of overload and automatically switches back on after a short time. If the overload persists, the process repeats until the fault is manually rectified. This means a fuse is never tripped. Using devices with a forward characteristic does not deliver success either. The power supply does not switch off, but supplies only a 1.1 to 1.2 times higher output current when the output voltage is reduced. This characteristic likewise does not trip an automatic circuit-breaker, or if it does, then only in the hours range. Furthermore, both output modes have the disadvantage that loads such as DC motors or capacitive consumers cannot be started. At additional cost, operation of heavy loads can be achieved in the simplest case by using a device with a higher output power or a device with integrated power boost.

In this, the device with power boost continuously supplies 1.2 to 1.3 times the nominal current in the temperature range up to +45°C. On reducing the output voltage, a maximum of 2.5 times the nominal current is reached which - dependent on the device itself and the characteristic of the automatic circuit-breaker - may be just enough to effect a shutdown.

Characteristics of automatic circuit-breakers

The trip curve of an automatic circuit-breaker with characteristic B (Figure 1) is considered by way of example. To record smaller overcurrents, a thermal trip in the minutes to hours range is used (hold >1h at $I = 1.13 \times I_{nom}$ and trip <1h at $I = 1.45 \times I_{nom}$). Switch-off in case of high overcurrents is effected by immediate magnetic tripping within 0.01 to 0.1 seconds. If such a device is used in conjunction with a 10A switched-mode power supply, the switch-off occurs at 1.2 times the nominal current only after 20 to 60 minutes. Even at 2.5 times nominal current (power boost) between 25 seconds and two minutes elapse until switch-off in the thermal range. In short: essential protection - in particular selective protection of connected devices - is not provided. The fuse essentially performs a dummy function. In the event of a short-circuit or faulty wire supply would be maintained at 2.5 times nominal current. System failure or even a cable fire may be the consequence.

Selective switch-off

Selective load protection means that in case of overload or short-circuit only the faulty current path is switched off, with no reactive effect on the supply. The standards EN60204-1 (line protection and fire prevention) and EN 61131-1 and -2 (operating states and storage) are also applicable to the rating of the overcurrent protection device in DC 24V circuits. In concrete terms, this means withstanding a mains power failure lasting 10ms without functional impairment, which demands the deployment of large input capacities. Furthermore, hazardous overcurrents must be reduced to a safe level within 5s. Rating is made more difficult by the fact that nowadays many parallel consumers are supplied by way of one protection element.

LÜTZE LOCC-Box – the intelligent current monitoring system



Figure 2: LOCC-Box single module

The ideal solution would be one which is capable of optimally operating capacitive loads to start heavy loads and quickly detecting an overcurrent in operation and switching off only the affected path. Such a system should of course store the fault so as to prevent danger from switching back on and permit diagnosis. The Lütze LOCC-Box system meets those requirements in a modular design with additional intelligent functions. To meet the widely varying demands on switch-off response, the LOCC-Box system features the facility to program 10 different characteristics by way of a switch. Both standard automatic unit characteristics and in particular custom characteristics can be implemented. The nominal current range can additionally be selected with locking settings from 1A to 10A. The adjustable current range and characteristic is very important when retrofitting, as in such cases the device protection often has to be modified and adapted. As additional information, the capacity utilisation of the path is indicated by an LED. When 90% of the programmed current value is reached the status LED starts to flash. In the event of a switch-off due to overcurrent or short-circuit, in addition to the visual indication by a red LED.

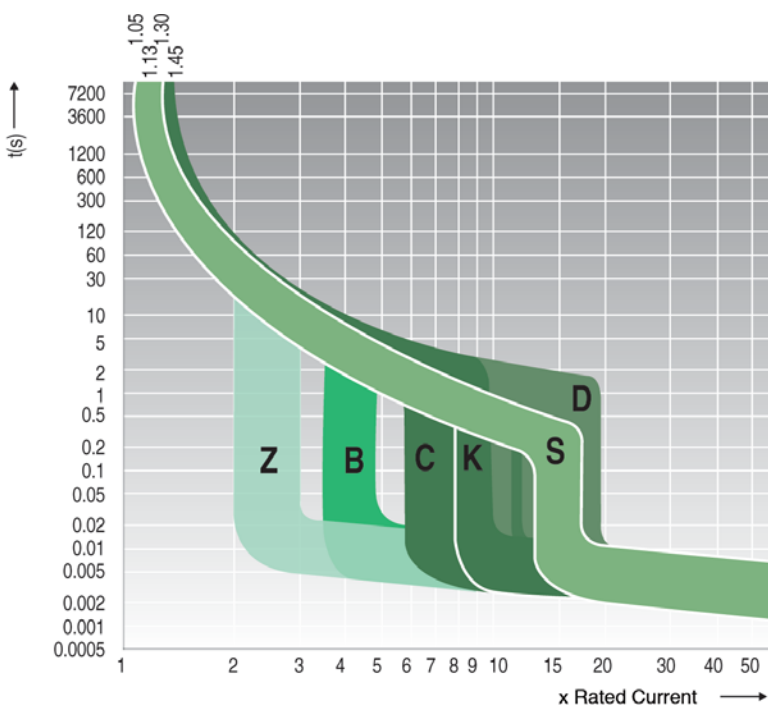

Current Control System · Basics

A 24V signal is set as a collective fault warning. This eliminates the need to install and wire additional auxiliary contacts. A restart after clearing the fault is then effected either using the mechanical switch on the device or from the main system by remote control. This channel-based switching facility is of great importance in particular in the commissioning phase of a system, as it enables individual system components to be activated and checked specifically.

LOCC-Box Practical and efficient

The monitoring function itself is one side of the coin. The other in many other systems is the associated mechanism. Frequently multi-channel solutions are offered on the market which only make sense if exactly the

available channels are required. If that is not the case, or if only one channel has to be additionally implemented subsequently, money and space will be wasted. Another disadvantage of this solution is the looping of up to 40A via a printed circuit board. This entails an enormous load on the carrier material and interruption of the entire supply when a device is replaced. What in other areas of automation has been state of the art for over 10 years is also ideal here as the solution in a highly modular configuration!

Here, too, the LOCC-Box system is setting new standards. The single-channel design with all the functionality described offers the highest possible flexibility. As shown below, customers can decide whether the supply is provided by each module individually or via the system supply (infeed terminal, copper

rail, end terminal). The particular advantage of this method of infeed is the screwless contact carriage, which permits exchanging of individual channels in operation without interrupting the entire supply. This additional provides functionality to switch off individual paths to perform essential work safely. The maximum supply current is dictated by the 6mm² terminal, and is DC 40A. The slim width of just 8.1mm results in an installed width of just 340mm even with a 40-channel configuration. The system housing is complemented by name plate labels, seals and a jumper system to loop signals.

Standard Application

without supply set, art. no. 716425 with supply set, art. no. 716425

Empty housing as placeholder

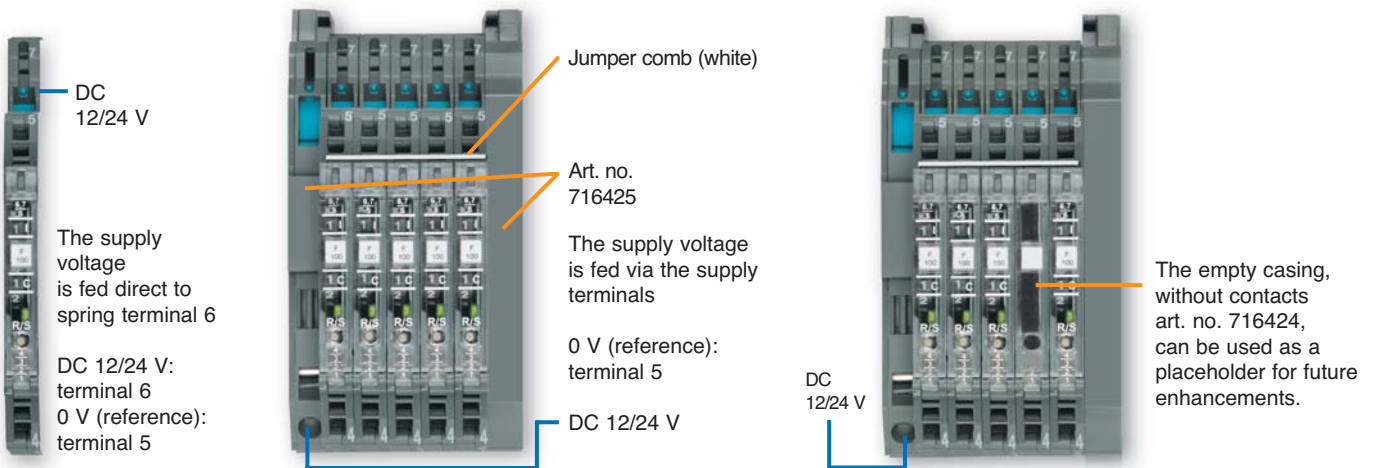

Use with additional supply terminals

Supply set, art. no. 716425 and supply terminal, art. no. 716421

The supply terminal is accessed via an aperture in the left hand side wall. This enables a variable positioning in the system construction. The maximum total current can thus be increased. Max. 160 A / 4 feeds.

Individual construction with distance terminal

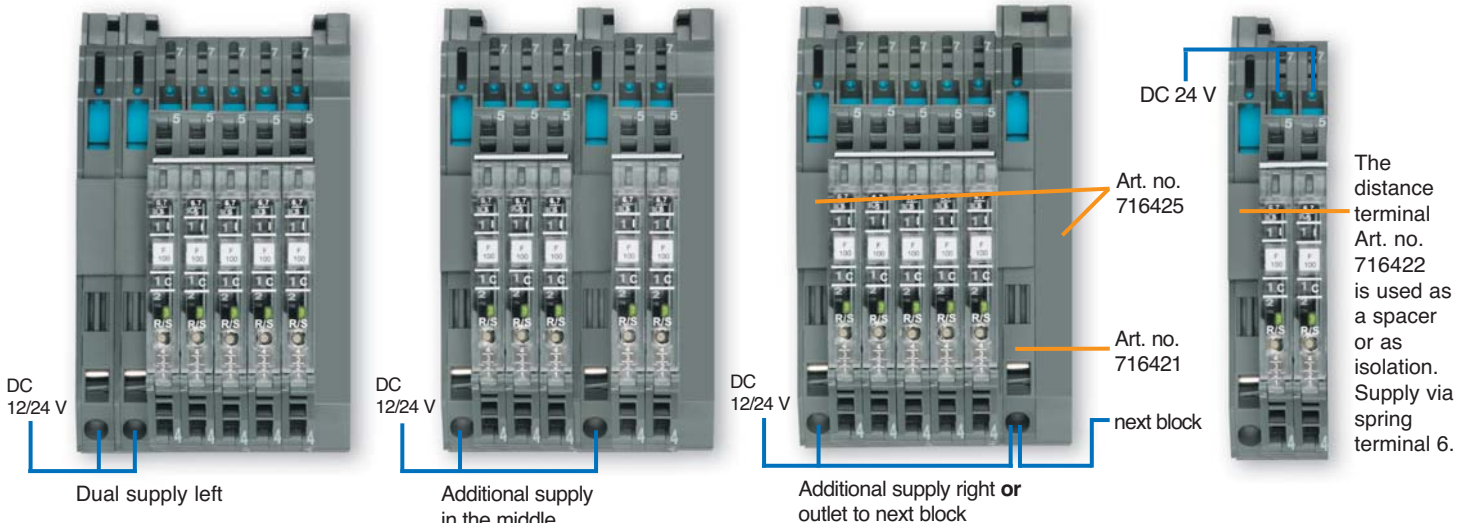

LCOS-CC • Application examples

e.g. Switching power supply 722814

DC 24 V, 100 A.

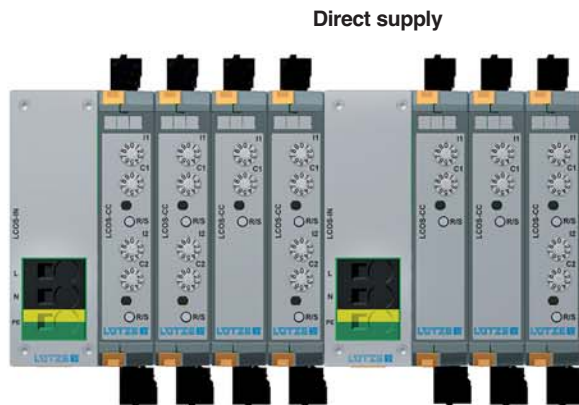
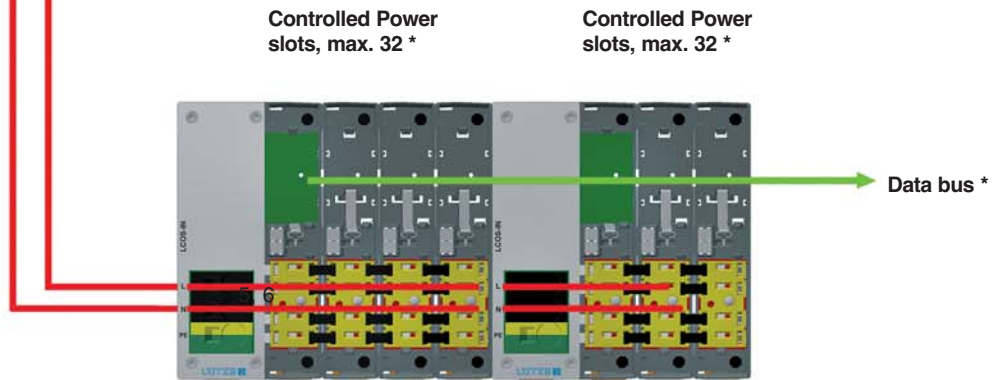

*Option with fieldbus – Design on request.

LOCC-Box / LOCC-Box-Net • Application examples

e.g. Switching power supply 722814

DC 24 V, 100 A.



Standard Application

with supply set, art. no. 716425

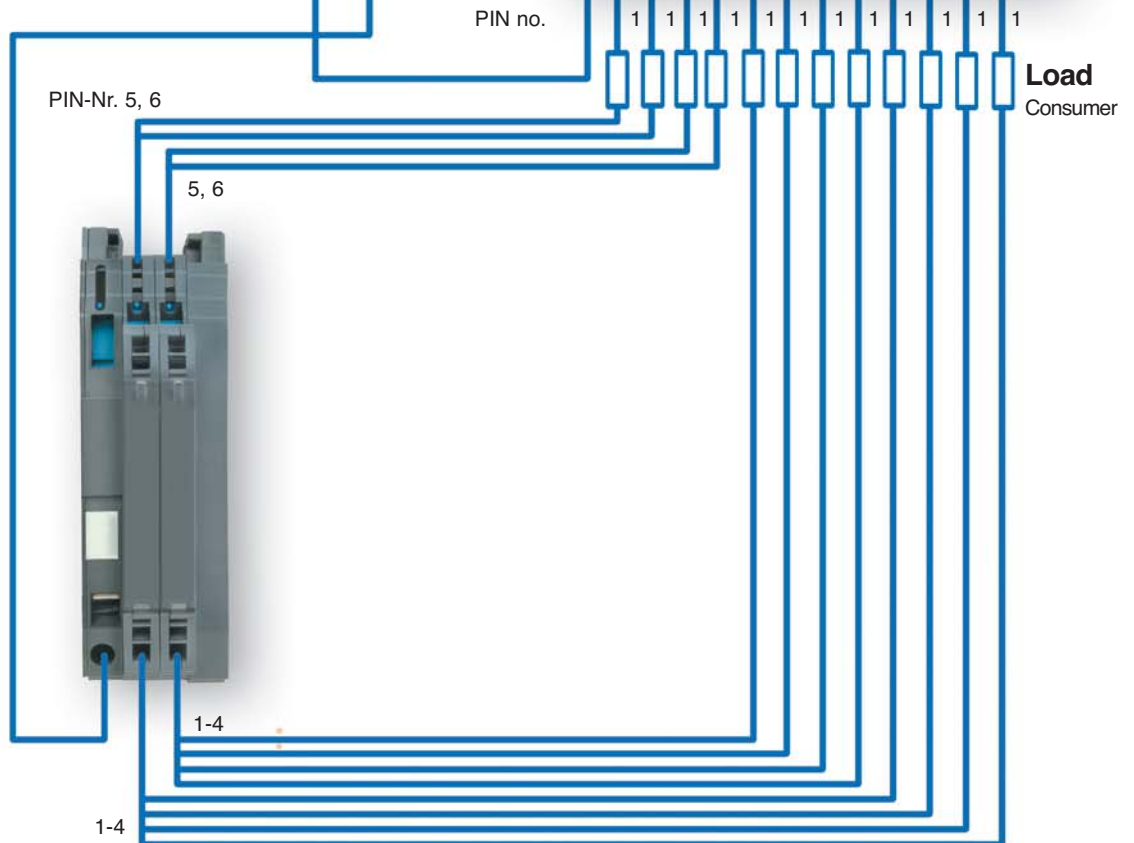
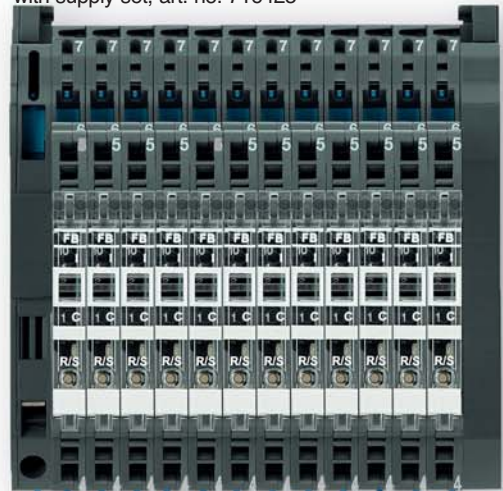

Application of the 0 V Collective terminal

with supply set
Art. no. 716425

Modular, flexible and safe: LOC

The intelligent LÜTZE Overload

Adjustable rated current
(1 A...10 A in 1 A Steps)

Adjustable characteristic
(fast- ... slow acting)

“Power-ON”-effect
to switch on capacitive loads

Single or centralized fault indication

Last status memorization

Spring terminals

Small device – width 8,1 mm

Response time independent
of temperature

Contact slots for each potential usable
for jumper combs

Solid state relay with current control
switching frequency up to 1 kHz

Contact slots for each potential usable for
jumper combs



C-Box / LOCC-Box-Net

Current Control System

*Sky***BLUE**

Remote ON / OFF

Manual ON / OFF

Status indication “operation”, “fault”,
“90 % load” and “100 % load”

Adjustment cover accommodates
lock out tags

Flammability class
UL-94-V0; NFF I2,F2

Power distribution via direct
supply or supply set

Optional remote Gateway interface

UL 508 Listed

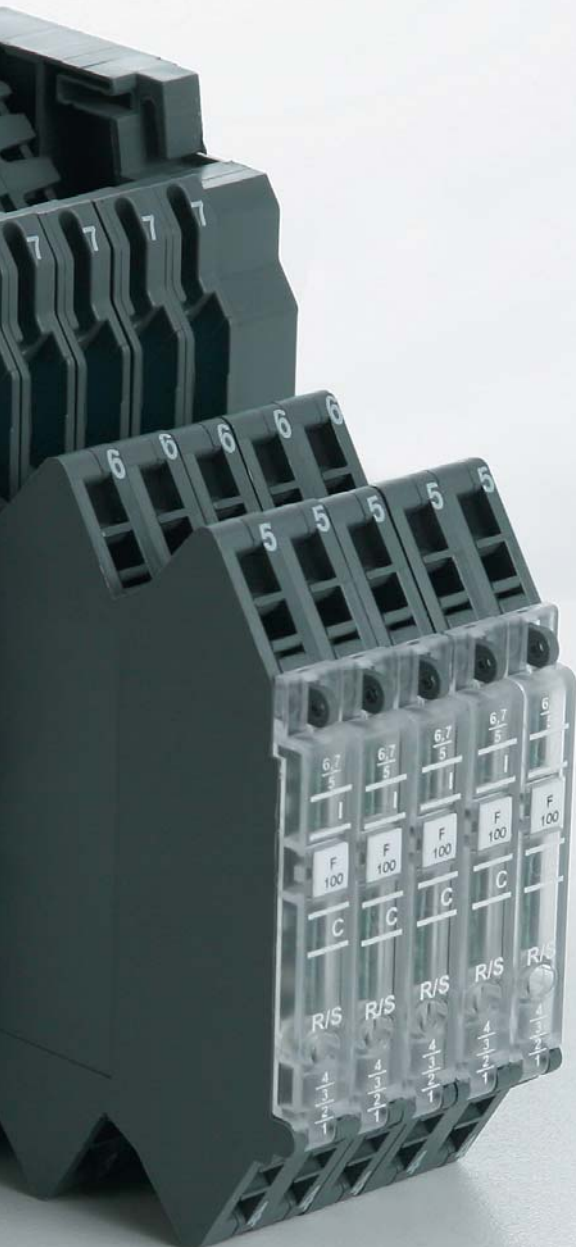

The picture shows 5 x LOCC-Box incl. supply set

Load monitoring · Microcompact LOCC-Box

Electronic load monitoring up to DC 10 A
 Single-channel design, Adjustable current range: DC 1 A – 10 A
 Adjustable characteristics, fast, medium, slow 1, -2, -3



Dimensions

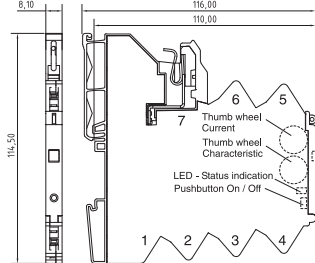

PIN assignment

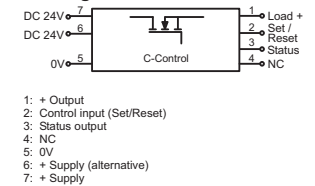

Signal output

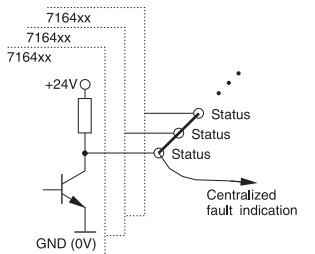
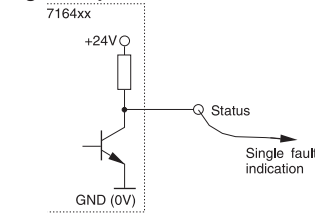

Description	Part-No.	Type	PU	
Spring terminal				
Nominal voltage	DC 12 / 24 V	716400	LOCC-Box-FB 7-6400	1
	DC 12 / 24 V	716401	LOCC-Box-FB 7-6401	1
	DC 12 / 24 V	716401.0050	LOCC-Box-FB 7-6401	50

Input	LOCC-Box-FB 7-6400	LOCC-Box-FB 7-6401
Nominal voltage		DC 12 / 24 V
Operation voltage range		DC 10 V – 30 V
Rated current		DC 10 A
Supply current		DC 40 A over Cu-rails 10 × 3 mm
Reverse voltage protection		internal electronics
Termination		screwless disconnect slide
Control input (Set / Reset)		
Signal level		DC 12 / 24 V (EN 61131)
OFF		Pulse with falling edge >100 ms, <800 ms
ON		Pulse with falling edge > 1 s
Output		
Switching element		MosFet
Output current		max. DC 10 A
Voltage drop		<170 mV (10 A)
Status Indication		LED green: Operating voltage present, no error LED red: Error in load circuit
Switch-on capacity		10000 µF
Current range		1 A – 10 A (adjustable via switch in 1 A steps)
Characteristic		fast-acting (1), medium (2), slow 1 (3), slow 2 (4), slow 3 (5) see 'characteristic curves'

Signal output	DC 12/24 V: operating voltage on standby, no error, DC 0 V: error, output switched off	DC 12/24 V: operating voltage on standby, no error, DC 0 V: error, output switched off and manual „OFF“
Signal level		

Switching element	Transistor, collector with pull-up resistance
General	
Housing material	PA 6.6 (UL 94-V0; NFF I2, F2)
Field installation	rail TS 35 (EN 60175)
Protection class	IP 20
Installation position	Optional
Termination	Spring terminal 0.25–2.5 mm ²
Operation temperature range	-25 °C – 50 °C
Storage temperature range	-40 – 85 °C
Dimensions (w × h × d) in mm	8.1 × 114.5 × 116.0
Weight (kg/piece)	0.120
Approvals	cULus, GL in preparation
Standards	EN 60950-1; EN 61131-1,2; EN 61000; EN 60947-4-1; EN 55022

Accessories	Color	Article number	Type	PU
0 V collective terminal		716420	LOCC Box-SK 7-6420	2
Supply terminal with cutout for copper rail to increase current		716421	LOCC Box-EKL 7-6421	2
Distance terminal without contact		716422	LOCC Box-DKL 7-6422	2
LOCC Box empty housing without terminal		716424	LOCC Box-DY 7-6424	2
Supply kit (supply and end terminals) 10 mm ²		716425	LOCC Box ES 7-6425	1
Supply kit (supply and end terminals) 16 mm ²		716447	LOCC Box ES 7-6477	1
Jumper comb, 8-pin, 6 A	white	716428	LOCC Box BKW 7-6428	5
Jumper comb, 8-pin, 6 A	red	716429	LOCC Box BKR 7-6429	5
Jumper comb, 8-pin, 6 A	blue	716430	LOCC Box BKB 7-6430	5
Jumper comb, 16-pin, 6 A	white	716438	LOCC Box BKW 7-6438	5
Jumper comb, 16-pin, 6 A	red	716439	LOCC Box BKB 7-6440	5
Jumper comb, 16-pin, 6 A	blue	716440	LOCC Box BKR 7-6439	5
Tag holder (quantity 200)	white (5×5 mm)	716431	LOCC Box BWZ 7-6431	1
Tag holder (quantity 200)	red (5×5 mm)	716432	LOCC Box BZR 7-6432	1
Tag holder (quantity 200)	blue (5×5 mm)	716433	LOCC Box BZB 7-6433	1
Tag holder (quantity 200)	yellow (5×5 mm)	716434	LOCC Box BZG 7-6434	1
Tag holder (quantity 120)	white (12×6 mm)	716441	LOCC Box BWZ 7-6441	1
Tag holder	white (39.3×5 mm)	716443	LOCC Box BWZ 7-6443	20
Cover for tag holder 716443	transparent	716444	LOCC Box-BAD 7-6444	20
A4 label sheets (quantity 240)	white	716445	LOCC Box-LEB 7-6445	10
Tag holder (quantity 50), printing 1–50	white	716446	LOCC Box BWZ 7-6446	1
Copper rail, 1 m		716426	LOCC Box CU 7-6426	1
CU rail cover, 1 m		716427	LOCC Box AD 7-6427	1

Load monitoring · Microcompact LOCC-Box

Electronic load monitoring up to DC 2 A

Single-channel design, Adjustable current range: DC 0.2 A – 2 A

Adjustable characteristics, fast, medium, slow



Dimensions

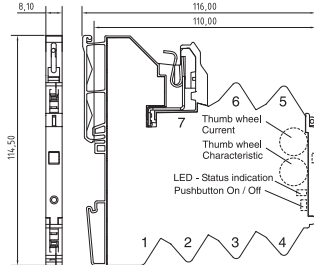

PIN assignment

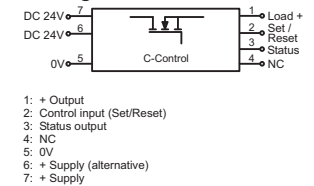

Signal output

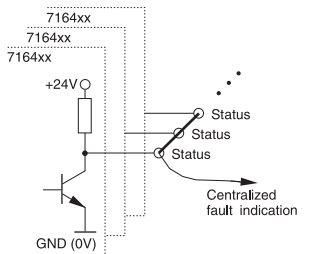
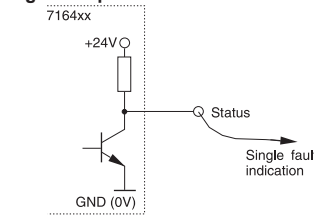

Description	Part-No.	Type	PU	
Spring terminal				
Nominal voltage	DC 12 / 24 V	716409	LOCC-Box-FB2A 7-6409	1
Input				
LOCC-Box-FB2A 7-6409				
Nominal voltage	DC 12 / 24 V			
Operation voltage range	DC 10 V – 32 V			
Rated current	DC 2 A			
Supply current	DC 40 A over Cu-rails 10 × 3 mm			
Reverse voltage protection	internal electronics			
Termination	screwless disconnect slide			
Control input (Set / Reset)				
Signal level	DC 12 / 24 V (EN 61131)			
OFF	Pulse with falling edge >100 ms, <800 ms			
ON	Pulse with falling edge > 1 s			
Output				
Switching element	MosFet			
Output current	max. DC 2 A			
Voltage drop	<140 mV (2 A)			
Status Indication	LED green: Operating voltage present, no error LED red: Error in load circuit			
Switch-on capacity	10000 µF			
Current range	0.2 A – 2 A (adjustable via switch in 0.2 A steps)			
Characteristic	fast (1), medium (2), slow 1 (3) see 'Characteristic curves'			
Current limitation	13.75 A			
Signal output				
Signal level	DC 12/24 V: operating voltage on standby, no error, DC 0 V: error, output switched off and manual "OFF"			
Switching element	Transistor, collector with pull-up resistance			
General				
Housing material	PA 6.6 (UL 94-V0; NFF I2, F2)			
Field installation	rail TS 35 (EN 60175)			
Protection class	IP 20			
Installation position	Optional			
Termination	Spring terminal 0.25–2.5 mm ²			
Operation temperature range	-25 °C – 50 °C			
Storage temperature range	-40 – 75 °C			
Dimensions (w × h × d) in mm	8.1 × 114.5 × 116.0			
Weight (kg/piece)	0.120			
Approvals	cULus, GL in preparation			
Standards	EN 60950-1; EN 61131-1,2; EN 61000; EN 60947-4-1; EN 55022			
Accessories				
0 V collective terminal	Color	Article number	Type	PU
Supply terminal with cutout for copper rail to increase current		716420	LOCC Box-SK 7-6420	2
Distance terminal without contact		716421	LOCC Box-EKL 7-6421	2
LOCC Box empty housing without terminal		716422	LOCC Box-DKL 7-6422	2
Supply kit (supply and end terminals) 10 mm ²		716424	LOCC Box-DY 7-6424	2
Supply kit (supply and end terminals) 16 mm ²		716425	LOCC Box ES 7-6425	1
Supply kit (supply and end terminals) 16 mm ²		716447	LOCC Box ES 7-6477	1
Jumper comb, 8-pin, 6 A	white	716428	LOCC Box BKW 7-6428	5
Jumper comb, 8-pin, 6 A	red	716429	LOCC Box BKR 7-6429	5
Jumper comb, 8-pin, 6 A	blue	716430	LOCC Box BKB 7-6430	5
Jumper comb, 16-pin, 6 A	white	716438	LOCC Box BKW 7-6438	5
Jumper comb, 16-pin, 6 A	red	716439	LOCC Box BKB 7-6440	5
Jumper comb, 16-pin, 6 A	blue	716440	LOCC Box BKR 7-6439	5
Tag holder (quantity 200)	white (5×5 mm)	716431	LOCC Box BZW 7-6431	1
Tag holder (quantity 200)	red (5×5 mm)	716432	LOCC Box BZR 7-6432	1
Tag holder (quantity 200)	blue (5×5 mm)	716433	LOCC Box BZB 7-6433	1
Tag holder (quantity 200)	yellow (5×5 mm)	716434	LOCC Box BKR 7-6434	1
Tag holder (quantity 120)	white (12×6 mm)	716441	LOCC Box BZW 7-6441	1
Tag holder	white (39.3×5 mm)	716443	LOCC Box BZW 7-6443	20
Cover for tag holder 716443	transparent	716444	LOCC Box-BAD 7-6444	20
A4 label sheets (quantity 240)	white	716445	LOCC Box-LEB 7-6445	10
Tag holder (quantity 50), printing 1–50	white	716446	LOCC Box BZW 7-6446	1
Copper rail, 1 m		716426	LOCC Box CU 7-6426	1
CU rail cover, 1 m		716427	LOCC Box AD 7-6427	1

Load monitoring · Microcompact LOCC-Box

Electronic load monitoring up DC 48 V to 6 A
 Single-channel design, Adjustable current range: DC 1 A – 6 A
 Adjustable characteristics, fast, medium, slow 1, -2, -3



Dimensions

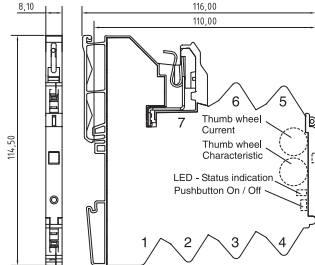

PIN assignment

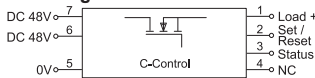

- 1: + Output
- 2: Control input (Set/Reset)
- 3: Status output
- 4: not used
- 5: 0V
- 6: + Supply (alternative)
- 7: + Supply

Signal output

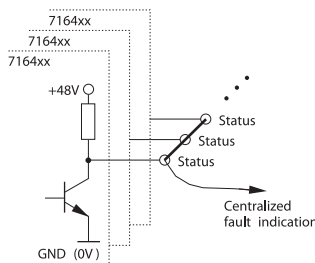
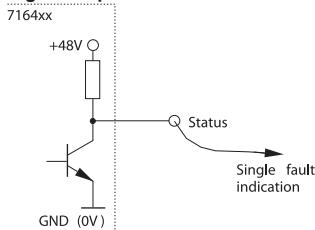

Description	Part-No.	Type	PU	
Spring terminal				
Nominal voltage	DC 48 V	716406	LOCC-Box-FB48 7-6406	1
Input				
LOCC-Box-FB48 7-6406				
Nominal voltage	DC 48 V			
Operation voltage range	DC 39 V – 58 V			
Rated current	DC 6 A			
Supply current	DC 40 A over Cu-rails 10 × 3 mm			
Reverse voltage protection	internal electronics			
Termination	screwless disconnect slide			
Control input (Set / Reset)				
Signal level	DC 48 V (EN 61131)			
OFF	Pulse with falling edge >100 ms, <800 ms			
ON	Pulse with falling edge > 1 s			
Output				
Switching element	MosFet			
Output current	max. DC 6 A			
Voltage drop	<85 mV (6 A)			
Status Indication	LED green: Operating voltage present, no error LED red: Error in load circuit			
Switch-on capacity	1000 µF			
Current range	1 A – 6 A (adjustable via switch in 1 A steps)			
Characteristic	fast (1), medium (2), slow 1 (3), slow 2 (4), slow 3 (5) see 'characteristic curves'			
Current limitation	13.75 A			
Signal output				
Signal level	DC 48 V: operating voltage on standby, no error, DC 0 V: error, output switched off and manual "OFF"			
Switching element	Transistor, collector with pull-up resistance			
General				
Housing material	PA 6.6 (UL 94-V0; NFF I2, F2)			
Field installation	rail TS 35 (EN 60175)			
Protection class	IP 20			
Installation position	Optional			
Termination	Spring terminal 0.25–2.5 mm ²			
Operation temperature range	-25 °C – 50 °C			
Storage temperature range	-40 – 75 °C			
Dimensions (w × h × d) in mm	8.1 × 114.5 × 116.0			
Weight (kg/piece)	0.120			
Approvals	cULus in progress, GL in progress			
Standards	EN 60950-1; EN 61131-1,2; EN 61000; EN 60947-4-1; EN 55022			
Accessories				
0 V collective terminal	Color	Article number	Type	PU
Supply terminal with cutout for copper rail to increase current		716420	LOCC Box-SK 7-6420	2
Distance terminal without contact		716422	LOCC Box-DKL 7-6422	2
LOCC Box empty housing without terminal		716424	LOCC Box-DY 7-6424	2
Supply kit (supply and end terminals) 10 mm ²		716425	LOCC Box ES 7-6425	1
Supply kit (supply and end terminals) 16 mm ²		716447	LOCC Box ES 7-6477	1
Jumper comb, 8-pin, 6 A	white	716428	LOCC Box BKW 7-6428	5
Jumper comb, 8-pin, 6 A	red	716429	LOCC Box BKR 7-6429	5
Jumper comb, 8-pin, 6 A	blue	716430	LOCC Box BKB 7-6430	5
Jumper comb, 16-pin, 6 A	white	716438	LOCC Box BKW 7-6438	5
Jumper comb, 16-pin, 6 A	red	716439	LOCC Box BKB 7-6440	5
Jumper comb, 16-pin, 6 A	blue	716440	LOCC Box BKR 7-6439	5
Tag holder (quantity 200)	white (5×5 mm)	716431	LOCC Box BWZ 7-6431	1
Tag holder (quantity 200)	red (5×5 mm)	716432	LOCC Box BZR 7-6432	1
Tag holder (quantity 200)	blue (5×5 mm)	716433	LOCC Box BZB 7-6433	1
Tag holder (quantity 200)	yellow (5×5 mm)	716434	LOCC Box BZG 7-6434	1
Tag holder (quantity 120)	white (12×6 mm)	716441	LOCC Box BWZ 7-6441	1
Tag holder	white (39.3×5 mm)	716443	LOCC Box BWZ 7-6443	20
Cover for tag holder 716443	transparent	716444	LOCC Box-BAD 7-6444	20
A4 label sheets (quantity 240)	white	716445	LOCC Box-LEB 7-6445	10
Tag holder (quantity 50), printing 1–50	white	716446	LOCC Box BWZ 7-6446	1
Copper rail, 1 m		716426	LOCC Box CU 7-6426	1
CU rail cover, 1 m		716427	LOCC Box AD 7-6427	1

Load monitoring · Microcompact LOCC-Box-EC

Electronic load monitoring up to DC 10 A

Single channel version, fixed current range: DC 1 A - 10 A (see order code)

Fixed characteristic: fast, medium, slow 1, -2, -3 (see order code)



Dimensions

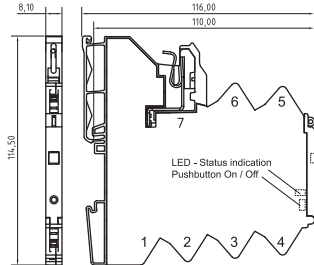

PIN assignment

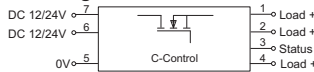

- 1: + Output
- 2: + Output
- 3: Status output
- 4: + Output
- 5: 0V
- 6: + Supply (alternative)
- 7: + Supply

Signal output

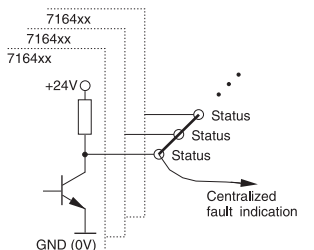
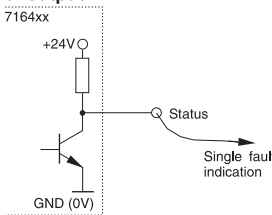

Order code

716407. 2 3 50	
Type	PU
	00 1 pc.
	50 50 pcs.
Current range	Characteristic
1 1A	1 fast
2 2A	2 medium
3 3A	3 slow-1
⋮	4 slow-2
0 10A	5 slow-3

Description	Part-No.	Type	PU
Spring terminal			
Nominal voltage	DC 12 / 24 V	716407.xxxx	LOCC-Box-EC-I-C
Input			
LOCC-Box-EC-I-C			
Nominal voltage	DC 12 / 24 V		
Operation voltage range	DC 10 V – 30 V		
Rated current	DC 10 A		
Supply current	DC 40 A over Cu-rails 10 × 3 mm		
Reverse voltage protection	internal electronics		
Termination	screwless disconnect slide		
Control input (Set / Reset)			
Signal level	-		
OFF	-		
ON	-		
Output			
Switching element	MosFet		
Output current	max. DC 10 A		
Voltage drop	<170 mV (10 A)		
Status Indication	LED green: Operating voltage present, no error LED red: Error in load circuit		
Switch-on capacity	10000 µF		
Current range	1 A – 10 A (see order code)		
Characteristic	fast (1), medium (2), slow 1 (3), slow 2 (4), slow 3 (5) (see order code), see 'Characteristic curves'		
Signal output			
Signal level	DC 12/24 V: operating voltage on standby, no error, DC 0 V: error, output switched off and manual "OFF"		
Switching element	Transistor, collector with pull-up resistance		
General			
Housing material	PA 6.6 (UL 94-V0; NFF I2, F2)		
Field installation	rail TS 35 (EN 60175)		
Protection class	IP 20		
Installation position	Optional		
Termination	Spring terminal 0.25–2.5 mm ²		
Operation temperature range	-25 °C – 50 °C		
Storage temperature range	-40 – 85 °C		
Dimensions (w × h × d) in mm	8.1 × 114.5 × 116.0		
Weight (kg/piece)	0.120		
Approvals	cULus, GL in preparation		
Standards	EN 60950-1; EN 61131-1.2; EN 61000; EN 60947-4-1; EN 55022		
Accessories			
0 V collective terminal	Color	Article number	Type PU
Supply terminal with cutout for copper rail to increase current		716420	LOCC Box-SK 7-6420 2
Distance terminal without contact		716421	LOCC Box-EKL 7-6421 2
LOCC Box empty housing without terminal		716422	LOCC Box-DKL 7-6422 2
		716424	LOCC Box-DY 7-6424 2
Supply kit (supply and end terminals) 10 mm ²		716425	LOCC Box ES 7-6425 1
Supply kit (supply and end terminals) 16 mm ²		716447	LOCC Box ES 7-6477 1
Jumper comb, 8-pin, 6 A	white	716428	LOCC Box BKW 7-6428 5
Jumper comb, 8-pin, 6 A	red	716429	LOCC Box BKR 7-6429 5
Jumper comb, 8-pin, 6 A	blue	716430	LOCC Box BKB 7-6430 5
Jumper comb, 16-pin, 6 A	white	716438	LOCC Box BKW 7-6438 5
Jumper comb, 16-pin, 6 A	red	716439	LOCC Box BKB 7-6440 5
Jumper comb, 16-pin, 6 A	blue	716440	LOCC Box BKR 7-6439 5
Tag holder (quantity 200)	white (5×5 mm)	716431	LOCC Box BZW 7-6431 1
Tag holder (quantity 200)	red (5×5 mm)	716432	LOCC Box BZR 7-6432 1
Tag holder (quantity 200)	blue (5×5 mm)	716433	LOCC Box BZB 7-6433 1
Tag holder (quantity 200)	yellow (5×5 mm)	716434	LOCC Box BZG 7-6434 1
Tag holder (quantity 120)	white (12×6 mm)	716441	LOCC Box BZW 7-6441 1
Tag holder	white (39.3×5 mm)	716443	LOCC Box BZW 7-6443 20
Cover for tag holder 716443	transparent	716444	LOCC Box-BAD 7-6444 20
A4 label sheets (quantity 240)	white	716445	LOCC Box-LEB 7-6445 10
Tag holder (quantity 50), printing 1–50	white	716446	LOCC Box BZW 7-6446 1
Copper rail, 1 m		716426	LOCC Box CU 7-6426 1
CU rail cover, 1 m		716427	LOCC Box AD 7-6427 1

Load monitoring · Microcompact LOCC-Box-EC

Electronic load monitoring up to DC 10 A

Single-channel design, Adjustable current range: DC 1 A – 10 A

Fixed characteristic: fast, medium, slow 1, -2, -3 (see order code)



Dimensions

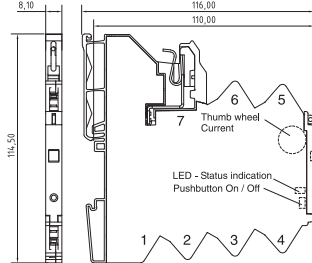

PIN assignment

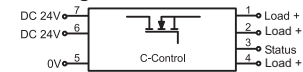

- 1: Load +
- 2: Load +
- 3: Status output
- 4: Load +
- 5: 0V
- 6: + Supply (alternative)
- 7: + Supply

Signal output

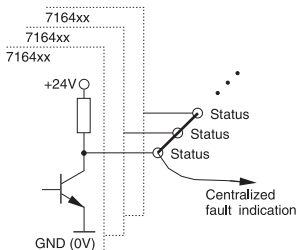
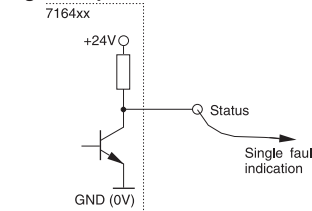

Order code

716412.03.50	
Type	PU
	00 1 pc.
	50 50 pcs.
Characteristic	
01	fast
02	medium
03	slow-1
04	slow-2
05	slow-3

Description	Part-No.	Type	PU
Spring terminal			
Nominal voltage	DC 12 / 24 V	716412.xxxx	LOCC-Box-EC-I-C
			1
Input			
LOCC-Box-EC-I-C			
Nominal voltage	DC 12 / 24 V		
Operation voltage range	DC 10 V – 30 V		
Rated current	DC 10 A		
Supply current	DC 40 A over Cu-rails 10 × 3 mm		
Reverse voltage protection	internal electronics		
Termination	screwless disconnect slide		
Control input (Set / Reset)			
Signal level	–		
OFF	–		
ON	–		
Output			
Switching element	MosFet		
Output current	max. DC 10 A		
Voltage drop	<170 mV (10 A)		
Status Indication	LED green: Operating voltage present, no error LED red: Error in load circuit		
Switch-on capacity	10000 µF		
Current range	1 A – 10 A (adjustable via switch in 1 A steps)		
Characteristic	fast (1), medium (2), slow 1 (3), slow 2 (4), slow 3 (5) (see order code), see 'Characteristic curves'		
Signal output			
Signal level	DC 12/24 V: operating voltage on standby, no error, DC 0 V: error, output switched off and manual "OFF"		
Switching element	Transistor, collector with pull-up resistance		
General			
Housing material	PA 6.6 (UL 94-V0; NFF I2, F2)		
Field installation	rail TS 35 (EN 60715)		
Protection class	IP 20		
Installation position	Optional		
Termination	Spring terminal 0.25–2.5 mm ²		
Operation temperature range	–25 °C – 50 °C		
Storage temperature range	–40 – 85 °C		
Dimensions (w × h × d) in mm	8.1 × 114.5 × 116.0		
Weight (kg/piece)	0.120		
Approvals	cULus in progress, GL in progress		
Standards	EN 60950-1; EN 61131-1,2; EN 61000; EN 60947-4-1; EN 55022		
Accessories			
	Color	Article number	Type PU
0 V collective terminal		716420	LOCC Box-SK 7-6420 2
Supply terminal with cutout for copper rail to increase current		716421	LOCC Box-EKL 7-6421 2
Distance terminal without contact		716422	LOCC Box-DKL 7-6422 2
LOCC Box empty housing without terminal		716424	LOCC Box-DY 7-6424 2
Supply kit (supply and end terminals) 10 mm ²		716425	LOCC Box ES 7-6425 1
Supply kit (supply and end terminals) 16 mm ²		716447	LOCC Box ES 7-6477 1
Jumper comb, 8-pin, 6 A	white	716428	LOCC Box BKW 7-6428 5
Jumper comb, 8-pin, 6 A	red	716429	LOCC Box BKR 7-6429 5
Jumper comb, 8-pin, 6 A	blue	716430	LOCC Box BKB 7-6430 5
Jumper comb, 16-pin, 6 A	white	716438	LOCC Box BKW 7-6438 5
Jumper comb, 16-pin, 6 A	red	716439	LOCC Box BKB 7-6440 5
Jumper comb, 16-pin, 6 A	blue	716440	LOCC Box BKR 7-6439 5
Tag holder (quantity 200)	white (5×5 mm)	716431	LOCC Box BZW 7-6431 1
Tag holder (quantity 200)	red (5×5 mm)	716432	LOCC Box BZR 7-6432 1
Tag holder (quantity 200)	blue (5×5 mm)	716433	LOCC Box BZW 7-6433 1
Tag holder (quantity 200)	yellow (5×5 mm)	716434	LOCC Box BZG 7-6434 1
Tag holder (quantity 120)	white (12×6 mm)	716441	LOCC Box BZW 7-6441 1
Tag holder	white (39.3×5 mm)	716443	LOCC Box BZW 7-6443 20
Cover for tag holder 716443	transparent	716444	LOCC Box-BAD 7-6444 20
A4 label sheets (quantity 240)	white	716445	LOCC Box-LEB 7-6445 10
Tag holder (quantity 50), printing 1–50	white	716446	LOCC Box BZW 7-6446 1
Copper rail, 1 m		716426	LOCC Box CU 7-6426 1
CU rail cover, 1 m		716427	LOCC Box AD 7-6427 1

Load monitoring · Microcompact LOCC-Box-SC

Electronic load monitoring up to DC 5 A
 Single-channel design, Adjustable current range: DC 1 A – 5 A
 Adjustable characteristics, fast, medium, slow 1



Dimensions

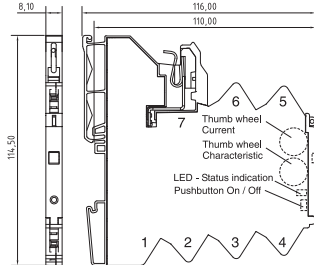

PIN assignment

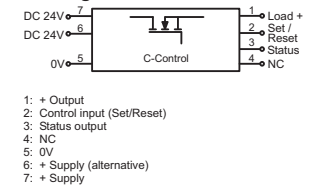

Signal output

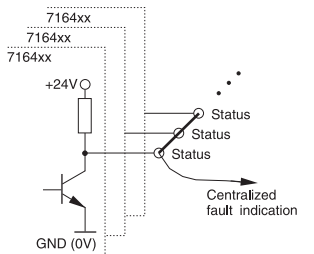
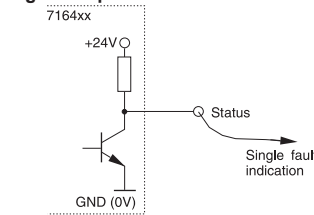

Description	Part-No.	Type	PU
Spring terminal			
Nominal voltage	DC 12 / 24 V	716408	LOCC-Box-SC 7-6408
			1
Input			
LOCC-Box-SC 7-6408			
Nominal voltage	DC 12 / 24 V		
Operation voltage range	DC 10 V – 30 V		
Rated current	DC 5 A		
Supply current	DC 40 A over Cu-rails 10 × 3 mm		
Reverse voltage protection	internal electronics		
Termination	screwless disconnect slide		
Control input (Set / Reset)			
Signal level	DC 12 / 24 V (EN 61131)		
OFF	Pulse with falling edge >100 ms, <800 ms		
ON	Pulse with falling edge > 1 s		
Output			
Switching element	MosFet		
Output current	max. DC 5 A		
Voltage drop	<85 mV (5 A)		
Status Indication	LED green: Operating voltage present, no error LED red: Error in load circuit		
Switch-on capacity	10000 µF		
Current range	1 A – 5 A (adjustable via switch in 1 A steps)		
Characteristic	fast (1), medium (2), slow 1 (3) see 'Characteristic curves'		
Signal output			
Signal level	DC 12/24 V: operating voltage on standby, no error, DC 0 V: error, output switched off and manual "OFF"		
Switching element	Transistor, collector with pull-up resistance		
General			
Housing material	PA 6.6 (UL 94-V0; NFF I2, F2)		
Field installation	rail TS 35 (EN 60175)		
Protection class	IP 20		
Installation position	Optional		
Termination	Spring terminal 0.25–2.5 mm ²		
Operation temperature range	-25 °C – 50 °C		
Storage temperature range	-40 – 85 °C		
Dimensions (w × h × d) in mm	8.1 × 114.5 × 116.0		
Weight (kg/piece)	0.120		
Approvals	cULus, GL in preparation		
Standards	EN 60950-1; EN 61131-1,2; EN 61000; EN 60947-4-1; EN 55022		
Accessories			
	Color	Article number	Type
0 V collective terminal		716420	LOCC Box-SK 7-6420
Supply terminal with cutout for copper rail to increase current		716421	LOCC Box-EKL 7-6421
Distance terminal without contact		716422	LOCC Box-DKL 7-6422
LOCC Box empty housing without terminal		716424	LOCC Box-DY 7-6424
Supply kit (supply and end terminals) 10 mm ²		716425	LOCC Box ES 7-6425
Supply kit (supply and end terminals) 16 mm ²		716447	LOCC Box ES 7-6477
Jumper comb, 8-pin, 6 A	white	716428	LOCC Box BKW 7-6428
Jumper comb, 8-pin, 6 A	red	716429	LOCC Box BKR 7-6429
Jumper comb, 8-pin, 6 A	blue	716430	LOCC Box BKB 7-6430
Jumper comb, 16-pin, 6 A	white	716438	LOCC Box BKW 7-6438
Jumper comb, 16-pin, 6 A	red	716439	LOCC Box BKB 7-6440
Jumper comb, 16-pin, 6 A	blue	716440	LOCC Box BKR 7-6439
Tag holder (quantity 200)	white (5×5 mm)	716431	LOCC Box BZW 7-6431
Tag holder (quantity 200)	red (5×5 mm)	716432	LOCC Box BZR 7-6432
Tag holder (quantity 200)	blue (5×5 mm)	716433	LOCC Box BZB 7-6433
Tag holder (quantity 200)	yellow (5×5 mm)	716434	LOCC Box BZG 7-6434
Tag holder (quantity 120)	white (12×6 mm)	716441	LOCC Box BZW 7-6441
Tag holder	white (39.3×5 mm)	716443	LOCC Box BZW 7-6443
Cover for tag holder 716443	transparent	716444	LOCC Box-BAD 7-6444
A4 label sheets (quantity 240)	white	716445	LOCC Box-LEB 7-6445
Tag holder (quantity 50), printing 1–50	white	716446	LOCC Box BZW 7-6446
Copper rail, 1 m		716426	LOCC Box CU 7-6426
CU rail cover, 1 m		716427	LOCC Box AD 7-6427

Load monitoring · Microcompact LOCC-Box Class 2

Electronic load monitoring up to DC 24 A - DC 4 A
Single channel version, adjustable current range, adjustable characteristic with current limitation acc. to NEC class 2



Dimensions

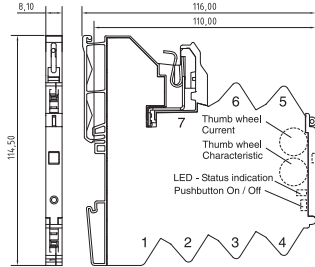

PIN assignment

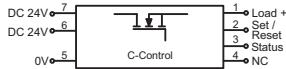

- 1: + Output
- 2: Control input (Set/Reset)
- 3: Status output
- 4: NC
- 5: 0V
- 6: + Supply (alternative)
- 7: + Supply

Signal output

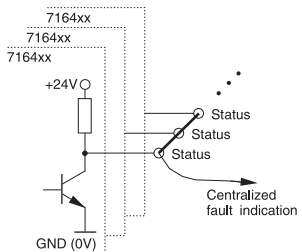
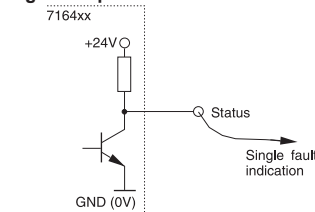

Description	Part-No.	Type	PU	
Spring terminal				
Nominal voltage	DC 12 / 24 V	716413	LOCC-Box-C2 7-6413	1
Input				
LOCC-Box-C2 7-6413				
Nominal voltage	DC 12 / 24 V			
Operation voltage range	DC 11 V – 30 V			
Rated current	DC 5 A			
Supply current	DC 40 A over Cu-rails 10 × 3 mm			
Reverse voltage protection	internal electronics			
Termination	screwless disconnect slide			
Control input (Set / Reset)				
Signal level	DC 24 V (EN 61131)			
OFF	Pulse with falling edge >100 ms, <800 ms			
ON	Pulse with falling edge > 1 s			
Output				
Switching element	MosFet			
Output current	max. DC 5 A			
Voltage drop	–			
Status Indication	LED green: Operating voltage present, no error LED red: Error in load circuit			
Switch-on capacity	4700 µF			
Current range	0.5 A – 4 A (can be set via switch in 0.5 A steps)			
Characteristic	fast (1), medium (2), slow 1 (3) see 'Characteristic curves'			
Signal output				
Signal level	DC 12/24 V: operating voltage on standby, no error, DC 0 V: error, output switched off and manual "OFF"			
Switching element	Transistor, collector with pull-up resistance			
General				
Housing material	PA 6.6 (UL 94-V0; NFF I2, F2)			
Field installation	rail TS 35 (EN 60175)			
Protection class	IP 20			
Installation position	Optional			
Termination	Spring terminal 0.25–2.5 mm ²			
Operation temperature range	–25 °C – 50 °C			
Storage temperature range	–40 – 75 °C			
Dimensions (w × h × d) in mm	8.1 × 114.5 × 116.0			
Weight (kg/piece)	0.120			
Approvals	cULus in progress, GL in progress, NEC class 2 in progress			
Standards	EN 60950-1; EN 61131-1,2; EN 61000; EN 60947-4-1; EN 55022			
Accessories				
0 V collective terminal	Color	Article number	Type	PU
Supply terminal with cutout for copper rail to increase current		716420	LOCC Box-SK 7-6420	2
Distance terminal without contact		716421	LOCC Box-EKL 7-6421	2
LOCC Box empty housing without terminal		716422	LOCC Box-DKL 7-6422	2
Supply kit (supply and end terminals) 10 mm ²		716424	LOCC Box-DY 7-6424	2
Supply kit (supply and end terminals) 16 mm ²		716425	LOCC Box ES 7-6425	1
Supply kit (supply and end terminals) 16 mm ²		716447	LOCC Box ES 7-6477	1
Jumper comb, 8-pin, 6 A	white	716428	LOCC Box BKW 7-6428	5
Jumper comb, 8-pin, 6 A	red	716429	LOCC Box BKR 7-6429	5
Jumper comb, 8-pin, 6 A	blue	716430	LOCC Box BKB 7-6430	5
Jumper comb, 16-pin, 6 A	white	716438	LOCC Box BKW 7-6438	5
Jumper comb, 16-pin, 6 A	red	716439	LOCC Box BKB 7-6440	5
Jumper comb, 16-pin, 6 A	blue	716440	LOCC Box BKR 7-6439	5
Tag holder (quantity 200)	white (5×5 mm)	716431	LOCC Box BZW 7-6431	1
Tag holder (quantity 200)	red (5×5 mm)	716432	LOCC Box BZR 7-6432	1
Tag holder (quantity 200)	blue (5×5 mm)	716433	LOCC Box BZB 7-6433	1
Tag holder (quantity 200)	yellow (5×5 mm)	716434	LOCC Box BZG 7-6434	1
Tag holder (quantity 120)	white (12×6 mm)	716441	LOCC Box BZW 7-6441	1
Tag holder	white (39.3×5 mm)	716443	LOCC Box BZW 7-6443	20
Cover for tag holder 716443	transparent	716444	LOCC Box-BAD 7-6444	20
A4 label sheets (quantity 240)	white	716445	LOCC Box-LEB 7-6445	10
Tag holder (quantity 50), printing 1–50	white	716446	LOCC Box BZW 7-6446	1
Copper rail, 1 m		716426	LOCC Box CU 7-6426	1
CU rail cover, 1 m		716427	LOCC Box AD 7-6427	1

Load monitoring · Microcompact LOCC Box-Net

Electronic load monitoring up to DC 10 A, with communication, parameterized
 Single-channel design, Adjustable current range: DC 1 A – 10 A
 Adjustable characteristics, fast, medium, slow 1, -2, -3



Dimensions

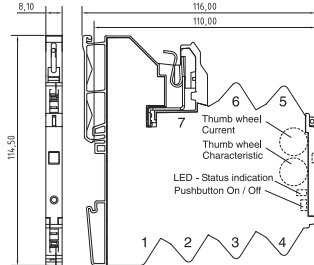

PIN assignment

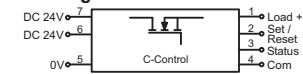

- 1: + Output
- 2: Control input (Set/Reset)
- 3: Status output
- 4: 1 Wire bus (Communication)
- 5: 0V
- 6: + Supply (alternative)
- 7: + Supply

Signal output

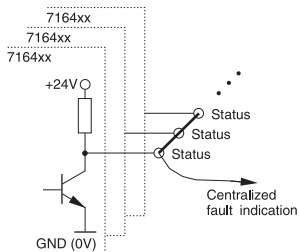
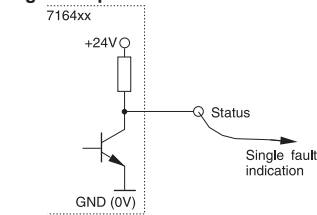

Description	Part-No.	Type	PU	
Spring terminal				
Nominal voltage	DC 12 / 24 V	716403	LOCC-Box-Net 7-6403	1
	DC 12 / 24 V	716404	LOCC-Box-Net 7-6404	1
Input				
	LOCC-Box-Net 7-6403		LOCC-Box-Net 7-6404	
Nominal voltage	DC 12 / 24 V			
Operation voltage range	DC 10 V – 32 V			
Rated current	DC 10 A			
Supply current	DC 40 A over Cu-rails 10 × 3 mm			
Reverse voltage protection	internal electronics			
Termination	screwless disconnect slide			
Control input (Set / Reset)				
Signal level	DC 12 / 24 V (EN 61131)			
OFF	Low level			
ON	High level (automatic reset)			
Output				
Switching element	MosFet			
Output current	max. DC 10 A			
Voltage drop	<170 mV (10 A)			
Status Indication	LED green: Operating voltage present, no error LED red: Error in load circuit			
Switch-on capacity	10000 µF			
Current range	1 A – 10 A (adjustable via switch in 1 A steps)			
Characteristic	fast (1), medium (2), slow 1 (3), slow 2 (4), slow 3 (5), can be configured (19) see 'Characteristic curves'			
Signal output				
Signal level	DC 12/24 V: Operating voltage present, no error; DC 0 V: error, output switched off, and manual "OFF" (parameterized)			
Switching element	Transistor, collector with pull-up resistance			
General				
Housing material	PA 6.6 (UL 94-V0; NFF I2, F2)			
Field installation	rail TS 35 (EN 60175)			
Protection class	IP 20			
Installation position	Optional			
Termination	Spring terminal 0.25–2.5 mm ²			
Operation temperature range	-25 °C – 50 °C			
Storage temperature range	-40 – 85 °C			
Dimensions (w × h × d) in mm	8.1 × 114.5 × 116.0			
Weight (kg/piece)	0.120			
Approvals	cULus, GL in preparation			
Standards	EN 60950-1; EN 61131-1,2; EN 61000; EN 60947-4-1; EN 55022			
Accessories				
	Color	Article number	Type	PU
0 V collective terminal		716420	LOCC Box-SK 7-6420	2
Supply terminal with cutout for copper rail to increase current		716421	LOCC Box-EKL 7-6421	2
Distance terminal without contact		716422	LOCC Box-DKL 7-6422	2
LOCC Box empty housing without terminal		716424	LOCC Box-DY 7-6424	2
Supply kit (supply and end terminals) 10 mm ²		716425	LOCC Box ES 7-6425	1
Supply kit (supply and end terminals) 16 mm ²		716447	LOCC Box ES 7-6477	1
Jumper comb, 8-pin, 6 A	white	716428	LOCC Box BKW 7-6428	5
Jumper comb, 8-pin, 6 A	red	716429	LOCC Box BKR 7-6429	5
Jumper comb, 8-pin, 6 A	blue	716430	LOCC Box BKB 7-6430	5
Jumper comb, 16-pin, 6 A	white	716438	LOCC Box BKW 7-6438	5
Jumper comb, 16-pin, 6 A	red	716439	LOCC Box BKB 7-6440	5
Jumper comb, 16-pin, 6 A	blue	716440	LOCC Box BKR 7-6439	5
Tag holder (quantity 200)	white (5×5 mm)	716431	LOCC Box BZW 7-6431	1
Tag holder (quantity 200)	red (5×5 mm)	716432	LOCC Box BZR 7-6432	1
Tag holder (quantity 200)	blue (5×5 mm)	716433	LOCC Box BZB 7-6433	1
Tag holder (quantity 200)	yellow (5×5 mm)	716434	LOCC Box BZG 7-6434	1
Tag holder (quantity 120)	white (12×6 mm)	716441	LOCC Box BZW 7-6441	1
Tag holder	white (39.3×5 mm)	716443	LOCC Box BZW 7-6443	20
Cover for tag holder 716443	transparent	716444	LOCC Box-BAD 7-6444	20
A4 label sheets (quantity 240)	white	716445	LOCC Box-LEB 7-6445	10
Tag holder (quantity 50), printing 1–50	white	716446	LOCC Box BZW 7-6446	1
Copper rail, 1 m		716426	LOCC Box CU 7-6426	1
CU rail cover, 1 m		716427	LOCC Box AD 7-6427	1

Load monitoring · Microcompact LOCC-Box-Net

Electronic load monitoring up to DC 10 A, with communication

Single-channel design, programmable, Adjustable current range: DC 1 A – 10 A

Adjustable characteristics, fast, medium, slow 1, -2, -3



Dimensions

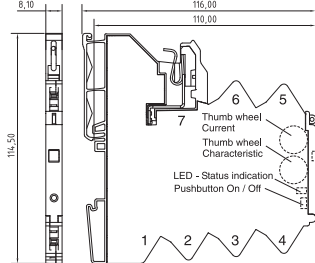

PIN assignment

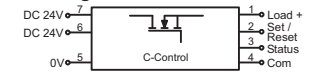

- 1: + Output
- 2: Control input (Set/Reset)
- 3: Status output
- 4: 1 Wire bus (Communication)
- 5: 0V
- 6: + Supply (alternative)
- 7: + Supply

Signal output

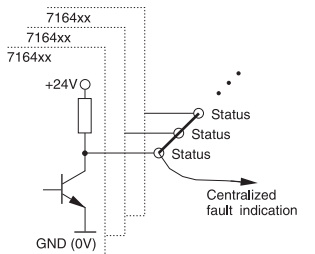
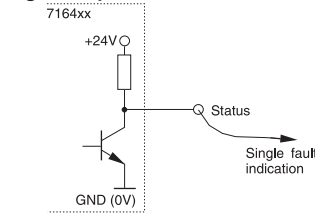

Description	Part-No.	Type	PU	
Spring terminal				
Nominal voltage	DC 12 / 24 V	716410	LOCC-Box-Net 7-6410	1
	DC 12 / 24 V	716410.0050	LOCC-Box-Net 7-6410	50

Input			
LOCC-Box-Net 7-6410			
Nominal voltage	DC 12 / 24 V		
Operation voltage range	DC 10 V – 30 V		
Rated current	DC 10 A		
Supply current	DC 40 A over Cu rail 10 × 3 mm		
Reverse voltage protection	internal electronics		
Termination	screwless disconnect slide		

Control input (Set / Reset)			
Signal level	DC 12 / 24 V (EN 61131)		
OFF	Pulse with falling edge >100 ms, <800 ms		
ON	Pulse with falling edge > 1 s		

Output			
Switching element	MosFet		
Output current	max. DC 10 A		
Voltage drop	<170 mV (10 A)		
Status Indication	LED green: Operating voltage present, no error LED red: Error in load circuit		
Switch-on capacity	10000 µF		
Current range	1 A – 10 A (adjustable via switch in 1 A steps)		
Characteristic	fast (1), medium (2), slow 1 (3), slow 2 (4), slow 3 (5), can be configured (19) see 'Characteristic curves'		

Signal output			
Signal level	DC 12/24 V: Operating voltage present, no error; DC 0 V: error, output switched off, and manual "OFF" (parameterized)		
Switching element	Transistor, collector with pull-up resistance		

General			
Housing material	PA 6.6 (UL 94-V0; NFF I2, F2)		
Field installation	rail TS 35 (EN 60175)		
Protection class	IP 20		
Installation position	Optional		
Termination	Spring terminal 0.25–2.5 mm ²		
Operation temperature range	-25 °C – 50 °C		
Storage temperature range	-40 – 85 °C		
Dimensions (w × h × d) in mm	8.1 × 114.5 × 116.0		
Weight (kg/piece)	0.120		
Approvals	cULus, GL in preparation		
Standards	EN 60950-1; EN 61131-1,2; EN 61000; EN 60947-4-1; EN 55022		

Accessories	Color	Article number	Type	PU
0 V collective terminal		716420	LOCC Box-SK 7-6420	2
Supply terminal with cutout for copper rail to increase current		716421	LOCC Box-EKL 7-6421	2
Distance terminal without contact		716422	LOCC Box-DKL 7-6422	2
LOCC Box empty housing without terminal		716424	LOCC Box-DY 7-6424	2
Supply kit (supply and end terminals) 10 mm ²		716425	LOCC Box ES 7-6425	1
Supply kit (supply and end terminals) 16 mm ²		716447	LOCC Box ES 7-6477	1
Jumper comb, 8-pin, 6 A	white	716428	LOCC Box BKW 7-6428	5
Jumper comb, 8-pin, 6 A	red	716429	LOCC Box BKR 7-6429	5
Jumper comb, 8-pin, 6 A	blue	716430	LOCC Box BKB 7-6430	5
Jumper comb, 16-pin, 6 A	white	716438	LOCC Box BKW 7-6438	5
Jumper comb, 16-pin, 6 A	red	716439	LOCC Box BKB 7-6440	5
Jumper comb, 16-pin, 6 A	blue	716440	LOCC Box BKR 7-6439	5
Tag holder (quantity 200)	white (5×5 mm)	716431	LOCC Box BZW 7-6431	1
Tag holder (quantity 200)	red (5×5 mm)	716432	LOCC Box BZR 7-6432	1
Tag holder (quantity 200)	blue (5×5 mm)	716433	LOCC Box BZB 7-6433	1
Tag holder (quantity 200)	yellow (5×5 mm)	716434	LOCC Box BZG 7-6434	1
Tag holder (quantity 120)	white (12×6 mm)	716441	LOCC Box BZW 7-6441	1
Tag holder	white (39.3×5 mm)	716443	LOCC Box BZW 7-6443	20
Cover for tag holder 716443	transparent	716444	LOCC Box-BAD 7-6444	20
A4 label sheets (quantity 240)	white	716445	LOCC Box-LEB 7-6445	10
Tag holder (quantity 50), printing 1–50	white	716446	LOCC Box BZW 7-6446	1
Copper rail, 1 m		716426	LOCC Box CU 7-6426	1
CU rail cover, 1 m		716427	LOCC Box AD 7-6427	1

Load monitoring · Microcompact LOCC Box-Net

Electronic load monitoring up to DC 10 A, with communication, without rotary switch
 Single-channel design, Adjustable current range: DC 1 A – 10 A
 Adjustable characteristic: fast, medium, slow 1, -2, -3 (see Software)



Dimensions

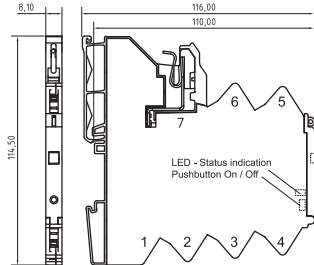

PIN assignment

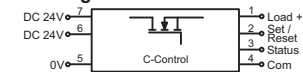

- 1: + Output
- 2: Control input (Set/Reset)
- 3: Status output
- 4: 1 Wire bus (Communication)
- 5: 0V
- 6: + Supply (alternative)
- 7: + Supply

Signal output

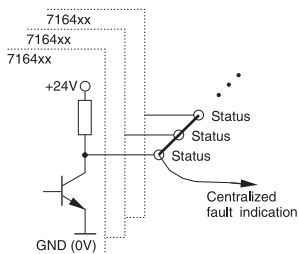
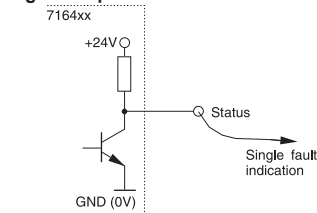

Description	Part-No.	Type	PU	
Nominal voltage	DC 12 / 24 V	716411	LOCC-Box-Net 7-6411	1
Input				
LOCC-Box-Net 7-6411				
Nominal voltage	DC 12 / 24 V			
Operation voltage range	DC 10 V – 32 V			
Rated current	DC 10 A			
Supply current	DC 40 A over Cu-rails 10 × 3 mm			
Reverse voltage protection	internal electronics			
Termination	screwless disconnect slide			
Control input (Set / Reset)				
Signal level	DC 12 / 24 V (EN 61131)			
OFF	Pulse with falling edge >100 ms, <800 ms			
ON	Pulse with falling edge > 1 s			
Output				
Switching element	MosFet			
Output current	max. DC 10 A			
Voltage drop	<170 mV (10 A)			
Status Indication	LED green: Operating voltage present, no error LED red: Error in load circuit			
Switch-on capacity	10000 µF			
Current range	1 A – 10 A (adjustable via software, EtherCAT, Profibus, CANopen)			
Characteristic	fast (1), medium (2), slow 1 (3), slow 2 (4), slow 3 (5), (adjustable via software, EtherCAT, Profibus, CANopen), see 'characteristic curves'			
Signal output				
Signal level	DC 12/24 V: Operating voltage present, no error; DC 0 V: error, output switched off, and manual "OFF" (parameterized)			
Switching element	Transistor, collector with pull-up resistance			
General				
Housing material	PA 6.6 (UL 94-V0; NFF I2, F2)			
Field installation	rail TS 35 (EN 60175)			
Protection class	IP 20			
Installation position	Optional			
Termination	Spring terminal 0.25–2.5 mm ²			
Operation temperature range	-25 °C – 50 °C			
Storage temperature range	-40 – 80 °C			
Dimensions (w × h × d) in mm	8.1 × 114.5 × 116.0			
Weight (kg/piece)	0.120			
Approvals	cULus, GL in preparation			
Standards	EN 60950-1; EN 61131-1,2; EN 61000; EN 60947-4-1; EN 55022			
Accessories				
0 V collective terminal	Color	Article number	Type	PU
Supply terminal with cutout for copper rail to increase current		716420	LOCC Box-SK 7-6420	2
Distance terminal without contact		716421	LOCC Box-EKL 7-6421	2
LOCC Box empty housing without terminal		716422	LOCC Box-DKL 7-6422	2
LOCC Box empty housing without terminal		716424	LOCC Box-DY 7-6424	2
Supply kit (supply and end terminals) 10 mm ²		716425	LOCC Box ES 7-6425	1
Supply kit (supply and end terminals) 16 mm ²		716447	LOCC Box ES 7-6477	1
Jumper comb, 8-pin, 6 A	white	716428	LOCC Box BKW 7-6428	5
Jumper comb, 8-pin, 6 A	red	716429	LOCC Box BKR 7-6429	5
Jumper comb, 8-pin, 6 A	blue	716430	LOCC Box BKB 7-6430	5
Jumper comb, 16-pin, 6 A	white	716438	LOCC Box BKW 7-6438	5
Jumper comb, 16-pin, 6 A	red	716439	LOCC Box BKB 7-6440	5
Jumper comb, 16-pin, 6 A	blue	716440	LOCC Box BKR 7-6439	5
Tag holder (quantity 200)	white (5×5 mm)	716431	LOCC Box BZW 7-6431	1
Tag holder (quantity 200)	red (5×5 mm)	716432	LOCC Box BZR 7-6432	1
Tag holder (quantity 200)	blue (5×5 mm)	716433	LOCC Box BZB 7-6433	1
Tag holder (quantity 200)	yellow (5×5 mm)	716434	LOCC Box BZG 7-6434	1
Tag holder (quantity 120)	white (12×6 mm)	716441	LOCC Box BZW 7-6441	1
Tag holder	white (39.3×5 mm)	716443	LOCC Box BZW 7-6443	20
Cover for tag holder 716443	transparent	716444	LOCC Box-BAD 7-6444	20
A4 label sheets (quantity 240)	white	716445	LOCC Box-LEB 7-6445	10
Tag holder (quantity 50), printing 1–50	white	716446	LOCC Box BZW 7-6446	1
Copper rail, 1 m		716426	LOCC Box CU 7-6426	1
CU rail cover, 1 m		716427	LOCC Box AD 7-6427	1

Load monitoring · Microcompact LOCC-Box-SC

Electronic load monitoring up to DC 5 A, with communication
 Single-channel design, Adjustable current range: DC 1 A – 5 A
 Adjustable characteristics, fast, medium, slow 1



Dimensions

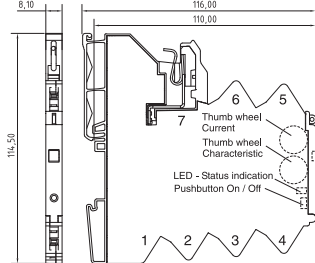

PIN assignment

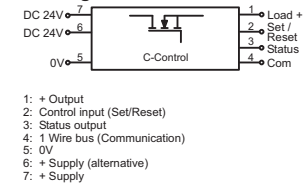

Signal output

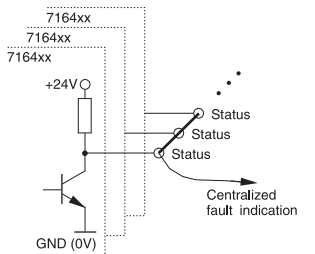
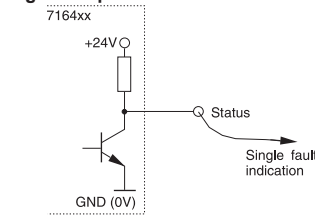

Description	Part-No.	Type	PU	
Spring terminal				
Nominal voltage	DC 12 / 24 V	716418	LOCC-Box-Net-SC 7-6418	1
Input				
LOCC-Box-Net-SC 7-6418				
Nominal voltage	DC 12 / 24 V			
Operation voltage range	DC 10 V – 30 V			
Rated current	DC 5 A			
Supply current	DC 40 A over Cu-rails 10 × 3 mm			
Reverse voltage protection	internal electronics			
Termination	screwless disconnect slide			
Control input (Set / Reset)				
Signal level	DC 12 / 24 V (EN 61131)			
OFF	Pulse with falling edge >100 ms, <800 ms			
ON	Pulse with falling edge > 1 s			
Output				
Switching element	MosFet			
Output current	max. DC 5 A			
Voltage drop	<85 mV (5 A)			
Status Indication	LED green: Operating voltage present, no error LED red: Error in load circuit			
Switch-on capacity	Optional µF			
Current range	1 A – 5 A (adjustable via switch in 1 A steps)			
Characteristic	fast (1), medium (2), slow 1 (3) see 'Characteristic curves'			
Signal output				
Signal level	DC 12/24 V: Operating voltage present, no error; DC 0 V: error, output switched off, and manual "OFF" (parameterized)			
Switching element	Transistor, collector with pull-up resistance			
General				
Housing material	PA 6.6 (UL 94-V0; NFF I2, F2)			
Field installation	rail TS 35 (EN 60175)			
Protection class	IP 20			
Installation position	Optional			
Termination	Spring terminal 0.25–2.5 mm ²			
Operation temperature range	-25 °C – 50 °C			
Storage temperature range	-40 – 85 °C			
Dimensions (w × h × d) in mm	8.1 × 114.5 × 116.0			
Weight (kg/piece)	0.120			
Approvals	cULus, GL in preparation			
Standards	EN 60950-1; EN 61131-1,2; EN 61000; EN 60947-4-1; EN 55022			
Accessories				
0 V collective terminal	Color	Article number	Type	PU
Supply terminal with cutout for copper rail to increase current		716420	LOCC Box-SK 7-6420	2
Distance terminal without contact		716421	LOCC Box-EKL 7-6421	2
LOCC Box empty housing without terminal		716422	LOCC Box-DKL 7-6422	2
Supply kit (supply and end terminals) 10 mm ²		716424	LOCC Box-DY 7-6424	2
Supply kit (supply and end terminals) 16 mm ²		716425	LOCC Box ES 7-6425	1
Jumper comb, 8-pin, 6 A	white	716427	LOCC Box ES 7-6477	1
Jumper comb, 8-pin, 6 A	red	716428	LOCC Box BKW 7-6428	5
Jumper comb, 8-pin, 6 A	blue	716429	LOCC Box BKR 7-6429	5
Jumper comb, 16-pin, 6 A	white	716430	LOCC Box BKB 7-6430	5
Jumper comb, 16-pin, 6 A	red	716438	LOCC Box BKW 7-6438	5
Jumper comb, 16-pin, 6 A	blue	716439	LOCC Box BKB 7-6440	5
Jumper comb, 16-pin, 6 A	yellow	716440	LOCC Box BKR 7-6439	5
Tag holder (quantity 200)	white (5×5 mm)	716431	LOCC Box BZW 7-6431	1
Tag holder (quantity 200)	red (5×5 mm)	716432	LOCC Box BZR 7-6432	1
Tag holder (quantity 200)	blue (5×5 mm)	716433	LOCC Box BZB 7-6433	1
Tag holder (quantity 200)	yellow (5×5 mm)	716434	LOCC Box BZG 7-6434	1
Tag holder (quantity 120)	white (12×6 mm)	716441	LOCC Box BZW 7-6441	1
Tag holder	white (39.3×5 mm)	716443	LOCC Box BZW 7-6443	20
Cover for tag holder 716443	transparent	716444	LOCC Box-BAD 7-6444	20
A4 label sheets (quantity 240)	white	716445	LOCC Box-LEB 7-6445	10
Tag holder (quantity 50), printing 1–50	white	716446	LOCC Box BZW 7-6446	1
Copper rail, 1 m		716426	LOCC Box CU 7-6426	1
CU rail cover, 1 m		716427	LOCC Box AD 7-6427	1

Load monitoring · Microcompact LOCC-Box-Net Class 2

Electronic load monitoring up to DC 24 A - DC 4 A, with communication
Single channel version, adjustable current range, adjustable characteristic
with current limitation acc. to NEC class 2



Dimensions

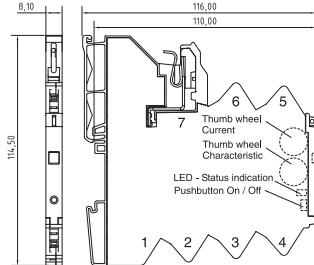

PIN assignment

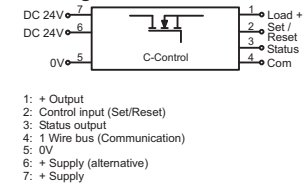

- 1: + Output
- 2: Control input (Set/Reset)
- 3: Status output
- 4: 1 Wire bus (Communication)
- 5: 0V
- 6: + Supply (alternative)
- 7: + Supply

Signal output

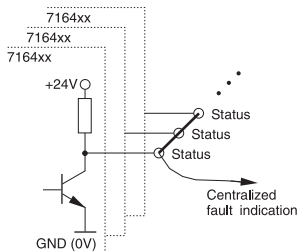
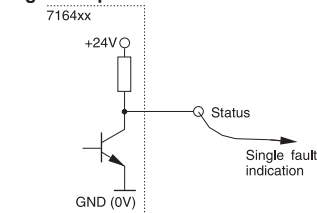

Description	Part-No.	Type	PU	
Spring terminal				
Nominal voltage	DC 12 / 24 V	716414	LOCC-Box-C2 NET 7-6414	1
Input				
LOCC-Box-C2 NET 7-6414				
Nominal voltage	DC 12 / 24 V			
Operation voltage range	DC 11 V – 30 V			
Rated current	DC 5 A			
Supply current	DC 40 A over Cu-rails 10 × 3 mm			
Reverse voltage protection	internal electronics			
Termination	screwless disconnect slide			
Control input (Set / Reset)				
Signal level	DC 24 V (EN 61131)			
OFF	Pulse with falling edge >100 ms, <800 ms			
ON	Pulse with falling edge > 1 s			
Output				
Switching element	MosFet			
Output current	max. DC 5 A			
Voltage drop	-			
Status Indication	LED green: Operating voltage present, no error LED red: Error in load circuit			
Switch-on capacity	4700 µF			
Current range	0.5 A – 4 A (can be set via switch in 0.5 A steps)			
Characteristic	fast (1), medium (2), slow 1 (3) see 'Characteristic curves'			
Signal output				
Signal level	DC 24 V: Operating voltage present, no error; DC 0 V: error, output switched off and manual "OFF"			
Switching element	Transistor, collector with pull-up resistance			
General				
Housing material	PA 6.6 (UL 94-V0; NFF I2, F2)			
Field installation	rail TS 35 (EN 60175)			
Protection class	IP 20			
Installation position	Optional			
Termination	Spring terminal 0.25–2.5 mm ²			
Operation temperature range	-25 °C – 50 °C			
Storage temperature range	-40 – 75 °C			
Dimensions (w × h × d) in mm	8.1 × 114.5 × 116.0			
Weight (kg/piece)	0.120			
Approvals	cULus in progress, GL in progress, NEC class 2 in progress			
Standards	EN 60950-1; EN 61131-1,2; EN 61000; EN 60947-4-1; EN 55022			

Accessories	Color	Article number	Type	PU
0 V collective terminal		716420	LOCC Box-SK 7-6420	2
Supply terminal with cutout for copper rail to increase current		716421	LOCC Box-EKL 7-6421	2
Distance terminal without contact		716422	LOCC Box-DKL 7-6422	2
LOCC Box empty housing without terminal		716424	LOCC Box-DY 7-6424	2
Supply kit (supply and end terminals) 10 mm ²		716425	LOCC Box ES 7-6425	1
Supply kit (supply and end terminals) 16 mm ²		716447	LOCC Box ES 7-6477	1
Jumper comb, 8-pin, 6 A	white	716428	LOCC Box BKW 7-6428	5
Jumper comb, 8-pin, 6 A	red	716429	LOCC Box BKR 7-6429	5
Jumper comb, 8-pin, 6 A	blue	716430	LOCC Box BKB 7-6430	5
Jumper comb, 16-pin, 6 A	white	716438	LOCC Box BKW 7-6438	5
Jumper comb, 16-pin, 6 A	red	716439	LOCC Box BKB 7-6440	5
Jumper comb, 16-pin, 6 A	blue	716440	LOCC Box BKR 7-6439	5
Tag holder (quantity 200)	white (5×5 mm)	716431	LOCC Box BZW 7-6431	1
Tag holder (quantity 200)	red (5×5 mm)	716432	LOCC Box BZR 7-6432	1
Tag holder (quantity 200)	blue (5×5 mm)	716433	LOCC Box BZB 7-6433	1
Tag holder (quantity 200)	yellow (5×5 mm)	716434	LOCC Box BZG 7-6434	1
Tag holder (quantity 120)	white (12×6 mm)	716441	LOCC Box BZW 7-6441	1
Tag holder	white (39.3×5 mm)	716443	LOCC Box BZW 7-6443	20
Cover for tag holder 716443	transparent	716444	LOCC Box-BAD 7-6444	20
A4 label sheets (quantity 240)	white	716445	LOCC Box-LEB 7-6445	10
Tag holder (quantity 50), printing 1–50	white	716446	LOCC Box BZW 7-6446	1
Copper rail, 1 m		716426	LOCC Box CU 7-6426	1
CU rail cover, 1 m		716427	LOCC Box AD 7-6427	1

Load monitoring · Microcompact gateway

Gateway for LOCC-Box-Net (716410)

Input: LOCCbus (LIN)

Output: USB, RS 232, CANopen



Dimensions

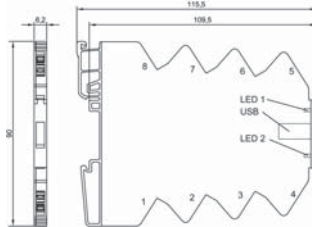

PIN assignment

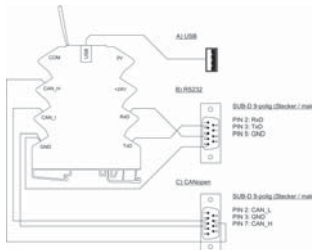

Description	Part-No.	Type	PU	
Spring terminal				
Nominal voltage	DC 12 / 24 V	716459	LOCC-Box-GW 7-6459	1
Input				
LOCC-Box-GW 7-6459				
Bus system	LOCCbus, basic LIN			
Access method	Single-Master - Multiple Slave			
Bus technology	Line			
Physical level	1-wire			
Participants	40, max. 254			
Bus length	max. 40 m			
Transfer rate	9600 Baud			
Data rate	8 Bit + fixed parity			
Transfer protocol	Modified multi-drop			
Output				
Bus system	USB 2.0 Full-Speed	RS232	CANopen	
Transfer rate	12 Mbit/s	600 – 11500 bit/s	10 – 1000 kbit/s	
General				
Nominal voltage	DC 12 / 24 V			
Operation voltage range	DC 10 V – 26.4 V			
Rated current	max. 50 mA			
Reverse voltage protection	Yes			
Status Indication	LED 1 green/red: USB, RS232, Firmware; LED 2 green/red: CANopen			
Insulation voltage	1.0 kV			
Housing material	PA 6.6 (UL 94-V0; NFF I2, F2)			
Field installation	rail TS 35 (EN 60175)			
Protection class	IP 20			
Installation position	Optional			
Termination	Spring terminal : 0.14 - 2.5 mm ² (with AE 1.5 mm ²)			
Operation temperature range	-20 °C – 60 °C			
Storage temperature range	-40 – 85 °C			
Dimensions (w × h × d) in mm	6.2 × 90.0 × 115.0			
Weight (kg/piece)	0.060			
Approvals	CE			
Standards	EN 60950-1, EN 61131-1, -2, EN 60898, EN 60947-4-1, EN 50081			
Accessories				
Tag holder 4×11 mm	Color	Article number	Type	PU
	white	681313	BZT 0411	100
Isolation plate		760809	TP 7-0809	5
Labels for laser printer A4 unpunched		681031	LEB - A4	1

Load monitoring · Gateway

Gateway for LOCC-Box-Net (716410)

Input: LOCCbus (LIN)

Output: USB, PROFINET-IO



Dimensions

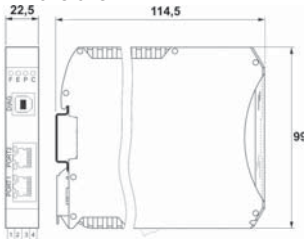

PIN assignment

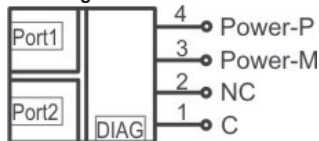

Description	Part-No.	Type	PU
Spring terminal			
Nominal voltage	DC 12 / 24 V	716457	LOCC-Box-GWPN 0-6457
Input			
Bus system	LOCCbus, basic LIN		
Access method	Single-Master - Multiple Slave		
Bus technology	Line		
Physical level	1-wire		
Participants	typ. 40, max. 100		
Bus length	max. 40 m		
Transfer rate	9600 Baud		
Data rate	8 Bit + fixed parity (Bit 9)		
Transfer protocol	Modified multi-drop		
Output			
Bus system	USB 2.0 Full-Speed	PROFINET-IO	
Transfer rate	12 Mbit/s	100 bit/s (IEE 802.3)	
Interface	USB connector, Type B	Port_1, Port_2, 2 × RJ-45 female with galvanic isolation and LEDs	
General			
Nominal voltage	DC 12 / 24 V		
Operation voltage range	10 – 32 V		
Rated current	120 mA @ 24 V		
Reverse voltage protection	Yes		
Status Indication	LED F, yellow - flashing: identification prompt (PROFINET) LED E, red - flashing: no connection (PROFINET) LED P, green - flashing: operating voltage is connected (POWER) LED C, green - flashing: data traffic with LOCC Box Net modules (LOCCbus) Link: yellow - 100Base/T-connection Activity green - valid connection, blanking: data traffic		
Insulation voltage	1.5 kV		
Housing material	PA (UL94-V0)		
Field installation	rail TS 35 (EN 60175)		
Protection class	IP 20		
Installation position	Optional		
Termination	Spring terminal : 0.14 - 2.5 mm ² (with AE 1.5 mm ²)		
Relative humidity	max. 90 % non-condensed		
Operation temperature range	-20 °C – 60 °C		
Storage temperature range	-40 – 85 °C		
Dimensions (w × h × d) in mm	22.5 × 99.0 × 114.5		
Weight (kg/piece)	0.130		
Approvals	CE		
Standards	EN 60950-1, EN 61131-1, -2, EN 60898, EN 60947-4-1, EN 50081		
Comments			
Screw terminal on request			

Use

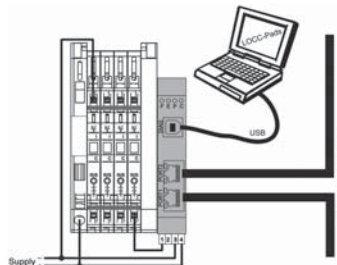

Load monitoring · Gateway

Gateway for LOCC-Box-Net (716410)

Input: LOCCbus (LIN)

Output: USB, PROFIBUS-DP



Dimensions

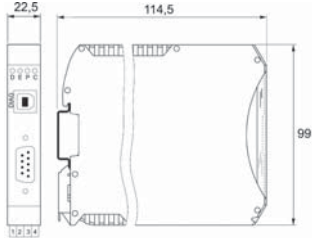

PIN assignment

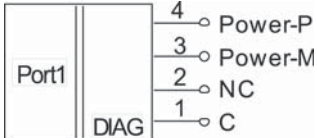

Description	Part-No.	Type	PU	
Spring terminal				
Nominal voltage	DC 12 / 24 V	716458	LOCC-Box-GWPB 0-6458	1
Input				
Bus system	LOCCbus, basic LIN			
Access method	Single-Master - Multiple Slave			
Bus technology	Line			
Physical level	1-wire			
Participants	typ. 40, max. 84			
Bus length	max. 40 m			
Transfer rate	9600 Baud			
Data rate	8 Bit + fixed parity (Bit 9)			
Transfer protocol	Modified multi-drop			
Output				
	USB	PROFIBUS-DP		
Bus system	USB 2.0 Full-Speed	PROFIBUS-DP		
Transfer rate	12 Mbit/s	max. 12 Mbit/s		
Interface	USB connector, Type B	Port_1, SUB-D 9pin with galvanic isolation		
General				
Nominal voltage	DC 12 / 24 V			
Operation voltage range	10 – 32 V			
Rated current	120 mA @ 24 V			
Reverse voltage protection	Yes			
Status Indication	LED D, green - on: data exchange via PROFIBUS-DP LED E, red - different flash codes for diagnosis of PROFIBUS-DP faults LED P, green - on: operating voltage is supplied (POWER) LED C, green - flashing: data traffic with LOCC-Box-Net modules (LOCCbus)			
Insulation voltage	1.5 kV			
Housing material	PA (UL94-V0)			
Field installation	rail TS 35 (EN 60175)			
Protection class	IP 20			
Installation position	Optional			
Termination	Spring terminal : 0.14 - 2.5 mm ² (with AE 1.5 mm ²)			
Relative humidity	max. 90 % non-condensed			
Operation temperature range	-20 °C – 60 °C			
Storage temperature range	-40 – 85 °C			
Dimensions (w × h × d) in mm	22.5 × 99.0 × 114.5			
Weight (kg/piece)	0.130			
Approvals	CE			
Standards	EN 60950-1, EN 61131-1, EN 61000, EN 60947-4-1, EN 50016			
Comments				
Screw terminal on request				

Use

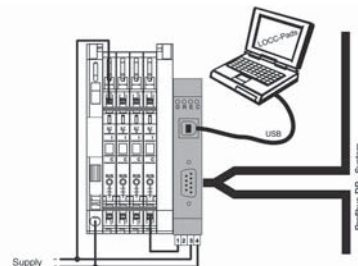

Load monitoring · Gateway

Gateway for LOCC-Box-Net (716410)

Input: LOCCbus (LIN)

Output: USB, EtherCAT



Dimensions

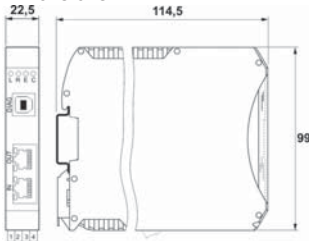

PIN assignment

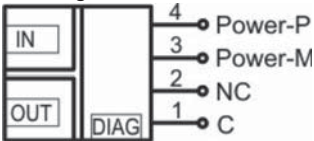

Description	Part-No.	Type	PU
Spring terminal			
Nominal voltage	DC 12 / 24 V	716456	LOCC-Box-GWEC 0-6456
1			
Input			
Bus system	LOCCbus, basic LIN		
Access method	Single-Master - Multiple Slave		
Bus technology	Line		
Physical level	1-wire		
Participants	typ. 40, max. 64		
Bus length	max. 40 m		
Transfer rate	9600 Baud		
Data rate	8 Bit + fixed parity (Bit 9)		
Transfer protocol	Modified multi-drop		
Output			
Bus system	USB 2.0 Full-Speed	EtherCAT	
Transfer rate	12 Mbit/s	100 bit/s (IEE 802.3)	
Interface	USB connector, Type B	IN, OUT, 2 × RJ-45 female with galvanic isolation and LEDs	
General			
Nominal voltage	DC 12 / 24 V		
Operation voltage range	10 – 32 V		
Rated current	55 mA @ 24 V		
Reverse voltage protection	Yes		
Status Indication	LED L, red - flashing: EEPROM error, EEPROM not loaded LED R, green - lit: ECT Run LED E, green - lit: ECT error LED C, green - flashing: data traffic with LOCC Box-Net modules (LOCCbus) link/activity: green - 100Base/T-connection, flashes with EtherCAT traffic Connect: yellow - speed LED, 100Base/T-connection		
Insulation voltage	1.5 kV		
Housing material	PA (UL94-V0)		
Field installation	rail TS 35 (EN 60175)		
Protection class	IP 20		
Installation position	Optional		
Termination	Spring terminal : 0.14 - 2.5 mm ² (with AE 1.5 mm ²)		
Relative humidity	max. 90 % non-condensed		
Operation temperature range	-20 °C – 60 °C		
Storage temperature range	-40 – 85 °C		
Dimensions (w × h × d) in mm	22.5 × 99.0 × 114.5		
Weight (kg/piece)	0.130		
Approvals	CE		
Standards	EN 60950-1, EN 61131-1, -2, EN 60898, EN 60947-4-1, EN 50081		
Comments			
Screw terminal on request			

Use

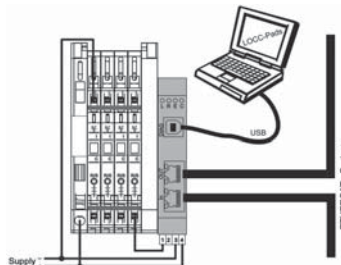

Load monitoring · Accessories

LOCC-Box supply set consisting of supply terminal and end block maximum total current 40 A



Dimensions Supply terminal

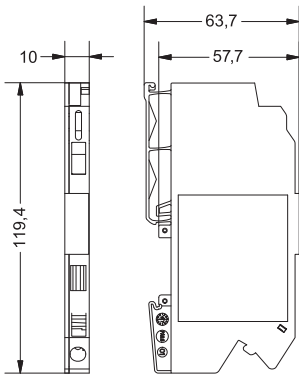

End block

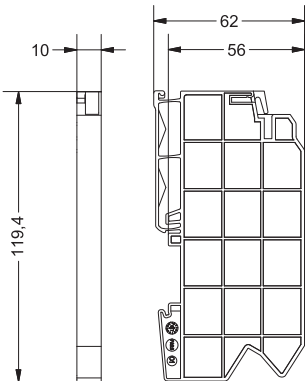

Description	Part-No.	Type	PU	
Nominal voltage	DC 12 / 24 V	716425	LOCC-Box-ES 7-6425	1
Input				
LOCC-Box-ES 7-6425				
Nominal voltage	DC 12 / 24 V			
Rated current	max. DC 40 A			
Reverse voltage protection	No			
Termination	Spring terminal : 0.33 – 10 mm ² (AWG 22–8) conductor connection cross section, single wire (solid): max. 10 mm ² conductor connection cross section, fine wire: max. 6 mm ² conductor connection cross section, fine wire with AEH: max. 6 mm ²			
Length of stripped insulation	12 mm			
Output				
Nominal voltage	DC 12 / 24 V			
Output current	max. DC 40 A			
Termination	screwless disconnect terminal			
Copper bus bar	3 × 10mm			
General				
Housing material	PA 6.6 (UL 94-V0; NFF I2, F2)			
Field installation	rail TS 35 (EN 60175)			
Protection class	IP 20			
Installation position	Optional			
Operation temperature range	-25 °C – 60 °C			
Storage temperature range	-40 – 85 °C			
Dimensions (w × h × d) in mm	10.0 × 119.4 × 63.7			
Weight (kg/piece)	0.035			
Approvals	cULus			
Standards	–			

Load monitoring · Accessories

LOCC-Box supply terminal maximum total current 40 A



Dimensions

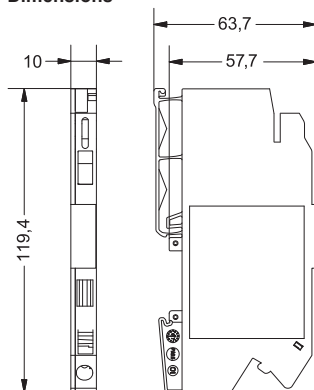

Description	Part-No.	Type	PU	
Nominal voltage	DC 12 / 24 V	716435	LOCC-Box-EKL 7-6435	2
Input				
LOCC-Box-EKL 7-6435				
Nominal voltage	DC 12 / 24 V			
Rated current	max. DC 40 A			
Reverse voltage protection	No			
Termination	Spring terminal : 0.33 – 10 mm ² (AWG 22–8) conductor connection cross section, single wire (solid): max. 10 mm ² conductor connection cross section, fine wire: max. 6 mm ² conductor connection cross section, fine wire with AEH: max. 6 mm ²			
Length of stripped insulation	12 mm			
Output				
Nominal voltage	DC 12 / 24 V			
Output current	max. DC 40 A			
Termination	screwless disconnect terminal			
Copper bus bar	3 × 10mm			
General				
Housing material	PA 6.6 (UL 94-V0; NFF I2, F2)			
Field installation	rail TS 35 (EN 60175)			
Protection class	IP 20			
Installation position	Optional			
Operation temperature range	-25 °C – 60 °C			
Storage temperature range	-40 – 85 °C			
Dimensions (w × h × d) in mm	10.0 × 119.4 × 63.7			
Weight (kg/piece)	0.035			
Approvals	cULus			
Standards	-			

Load monitoring · Accessories

LOCC-Box end block



Description	Part-No.	Type	PU
Nominal voltage	716436	LOCC-Box-EB 7-6436	2
General			
Housing material	PA 6.6 (UL 94-V0; NFF I2, F2)		
Field installation	rail TS 35 (EN 60175)		
Protection class	IP 20		
Installation position	Optional		
Operation temperature range	-25 °C – 60 °C		
Storage temperature range	-40 – 85 °C		
Dimensions (w × h × d) in mm	10.0 × 119.4 × 62.0		
Weight (kg/piece)	0.010		
Approvals	cULus		
Standards	-		

Dimensions

End block

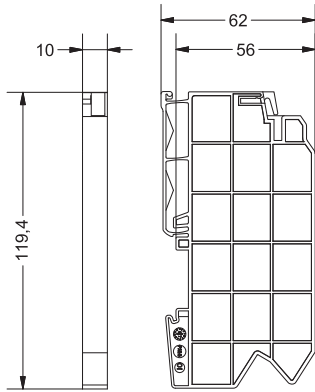

Load monitoring · Accessories

LOCC-Box supply terminal Additional supply terminal for increased current maximum total current 40 A



Dimensions

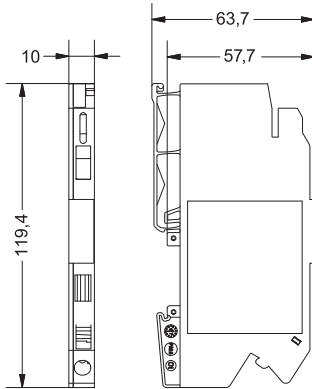

Use



Description	Part-No.	Type	PU	
Nominal voltage	DC 12 / 24 V	716421	LOCC-Box-EKL 7-6421	2
Input				
LOCC-Box-EKL 7-6421				
Nominal voltage	DC 12 / 24 V			
Rated current	max. DC 40 A			
Reverse voltage protection	No			
Termination	Spring terminal : 0.33 – 10 mm ² (AWG 22–8) conductor connection cross section, single wire (solid): max. 10 mm ² conductor connection cross section, fine wire: max. 6 mm ² conductor connection cross section, fine wire with AEH: max. 6 mm ²			
Length of stripped insulation	12 mm			
Output				
Nominal voltage	DC 12 / 24 V			
Output current	max. DC 40 A			
Termination	screwless disconnect terminal			
Copper bus bar	3 × 10mm			
General				
Housing material	PA 6.6 (UL 94-V0; NFF I2, F2)			
Field installation	rail TS 35 (EN 60175)			
Protection class	IP 20			
Installation position	Optional			
Operation temperature range	-25 °C – 60 °C			
Storage temperature range	-40 – 85 °C			
Dimensions (w × h × d) in mm	10.0 × 119.4 × 63.7			
Weight (kg/piece)	0.035			
Approvals	cULus			
Standards	–			

Load monitoring · Accessories

LOCC-Box supply set consisting of supply terminal and end block maximum total current 40 A



Dimensions Supply terminal

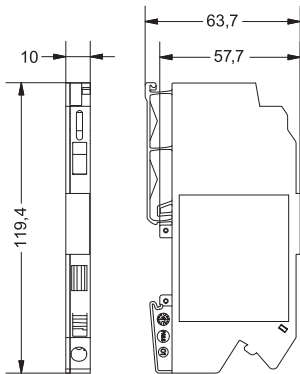

End block

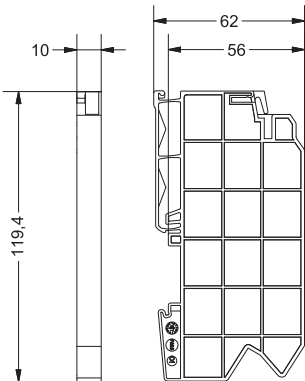

Description	Part-No.	Type	PU	
Nominal voltage	DC 12 / 24 V	716447	LOCC-Box-ES 7-6447	1
Input				
LOCC-Box-ES 7-6447				
Nominal voltage	DC 12 / 24 V			
Rated current	max. DC 40 A			
Reverse voltage protection	No			
Termination	Spring terminal : 0.33 – 16 mm ² (AWG 22–6) conductor connection cross section, single wire (solid): max. 16 mm ² conductor connection cross section, fine wire: max. 10 mm ² conductor connection cross section, fine wire with AEH: max. 10 mm ²			
Length of stripped insulation	12 mm			
Output				
Nominal voltage	DC 12 / 24 V			
Output current	max. DC 40 A			
Termination	screwless disconnect terminal			
Copper bus bar	3 × 10mm			
General				
Housing material	PA 6.6 (UL 94-V0; NFF I2, F2)			
Field installation	rail TS 35 (EN 60175)			
Protection class	IP 20			
Installation position	Optional			
Operation temperature range	-25 °C – 60 °C			
Storage temperature range	-40 – 85 °C			
Dimensions (w × h × d) in mm	10.0 × 119.4 × 63.7			
Weight (kg/piece)	–			
Approvals	cULus			
Standards	–			

Load monitoring · Accessories

LOCC-Box 0V Collective Terminal Single-channel design maximum total current 40 A



Dimensions

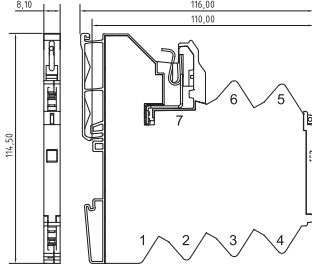

PIN assignment

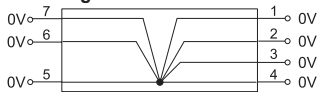

Description	Part-No.	Type	PU	
Nominal voltage	DC 12 / 24 V	716420	LOCC-Box-SK 7-6420	2
Input		LOCC-Box-SK 7-6420		
Nominal voltage	DC 12 / 24 V			
Rated current	6 × max. DC 10 A			
Reverse voltage protection	No			
Termination	Spring terminal: 0.25–2.5 mm ²			
Connection	1 – 6			
Output				
Output current	max. DC 40 A			
Voltage drop	–			
Termination	screwless disconnect terminal			
Connection	7			
General				
Housing material	PA 6.6 (UL 94-V0; NFF I2, F2)			
Field installation	rail TS 35 (EN 60175)			
Protection class	IP 20			
Installation position	Optional			
Operation temperature range	–25 °C – 60 °C			
Storage temperature range	–40 – 85 °C			
Dimensions (w × h × d) in mm	8.1 × 114.5 × 116.0			
Weight (kg/piece)	0.700			
Approvals	–			
Standards	–			

Load monitoring · Accessories

LOCC-Box supply terminal LOCC-Box supply terminal for power distribution maximum total current 40 A



Dimensions
Supply terminal

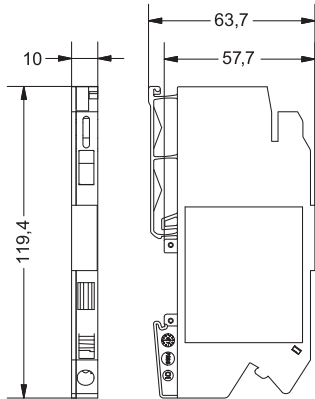
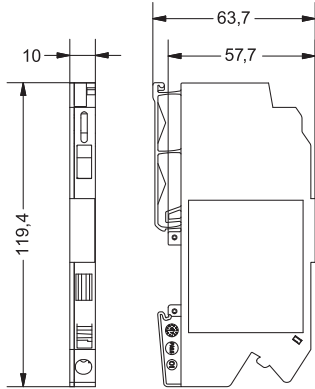

Description	Part-No.	Type	PU	
Nominal voltage	DC 12 / 24 V	716437	LOCC-Box-ES 7-6437	1
Input				
LOCC-Box-ES 7-6437				
Nominal voltage	DC 12 / 24 V			
Rated current	max. DC 40 A			
Reverse voltage protection	No			
Termination	Spring terminal : 0.33 – 10 mm ² (AWG 22–8) conductor connection cross section, single wire (solid): max. 10 mm ² conductor connection cross section, fine wire: max. 6 mm ² conductor connection cross section, fine wire with AEH: max. 6 mm ²			
Length of stripped insulation	12 mm			
Output				
Nominal voltage	DC 12 / 24 V			
Output current	max. DC 40 A			
Termination	screwless disconnect terminal			
Copper bus bar	3 × 10mm			
General				
Housing material	PA 6.6 (UL 94-V0; NFF I2, F2)			
Field installation	rail TS 35 (EN 60175)			
Protection class	IP 20			
Installation position	Optional			
Operation temperature range	-25 °C – 60 °C			
Storage temperature range	-40 – 85 °C			
Dimensions (w × h × d) in mm	10.0 × 119.4 × 63.7			
Weight (kg/piece)	0.035			
Approvals	cULus			
Standards	–			

LOCC-Pads • Monitoring software

LOCC-Pads*

Software for the parameterisation of the LOCC-Box-Net, as well as the analysis and diagnosis of DC 12 / 24 V circuits

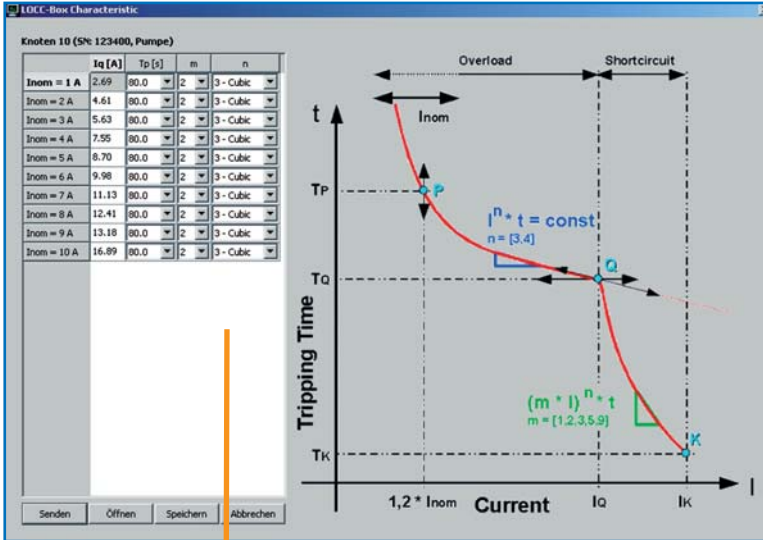

Adjustment parameters for the parameterisable characteristic No. 10

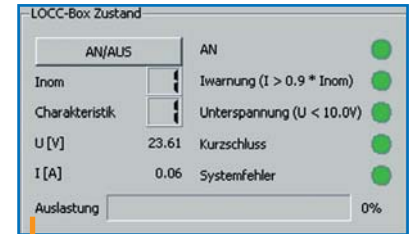

Displays the operating status, current range / characteristic, the load capacity of the characteristic, as well as the updated current and voltage values.

- COM Einstellung
- LOCC-Box Charakteristik
- LOCC-Box Module
- LOCC-Box Aufzeichnung
- LOCC-Box Einstellung
- LOCC-Box Gateway
- Firmware Download
- Sprache

Menu "Extra"

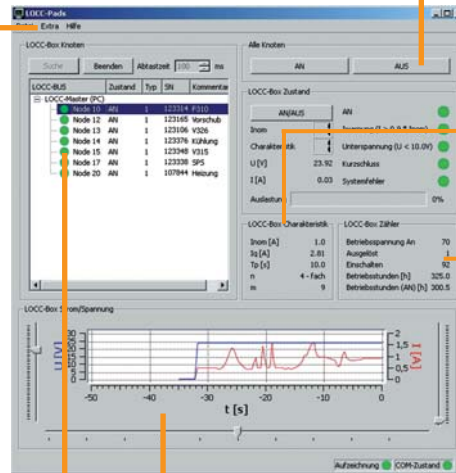

Overall view

Inom [A]	1.0
Iq [A]	2.81
TP [s]	10.0
n	4 - fach
m	9

Displays the parameters of the selected characteristic curve.

Datum/Zeit	Knoten	Zustand	Fehler	I [A]	U [V]	Kommentar
2008-12-09 11:23:42						Aufzeichnung gestartet ...
2008-12-09 11:23:43	17	AN		0.06	23.92	SPS
2008-12-09 11:23:43	10	AN		0.06	23.61	Pumpe
2008-12-09 11:23:44	11	AN		0.03	23.92	L
2008-12-09 11:23:44	12	AN		0.06	23.77	Motor 1
2008-12-09 11:23:44	13	AN		0.06	23.46	V326
2008-12-09 11:23:45	14	AN		0.03	24.22	L
2008-12-09 11:23:45	15	AN		0.03	23.92	V315
2008-12-09 11:24:01	10	Ausgelöst	Kurzschluss	0.06	23.61	Pumpe
2008-12-09 11:24:07	10	AUS	Kurzschluss	0.00	0.00	Pumpe
2008-12-09 11:24:09	10	AN		0.06	23.61	Pumpe

Recording of all results such as "ON", "OFF" or "SHORT CIRCUIT" with date and time

Betriebsspannung An	42
Ausgelöst	39
Einschalten	142
Betriebsstunden [h]	144.0
Betriebsstunden (AN) [h]	108.5

Indicates the current meter readings of the selected module

LOCC-BUS	Zustand	Typ	SN	Kommentar
LOCC-Master (PC)				
Node 10	AN	1	123400	Pumpe
Node 11	AN	1	123314	L
Node 12	AN	1	123165	Motor 1
Node 13	AN	1	123106	V326
Node 14	AN	1	123376	L
Node 15	AN	1	123348	V315
Node 17	AN	1	123338	SPS

Overview of all connected modules

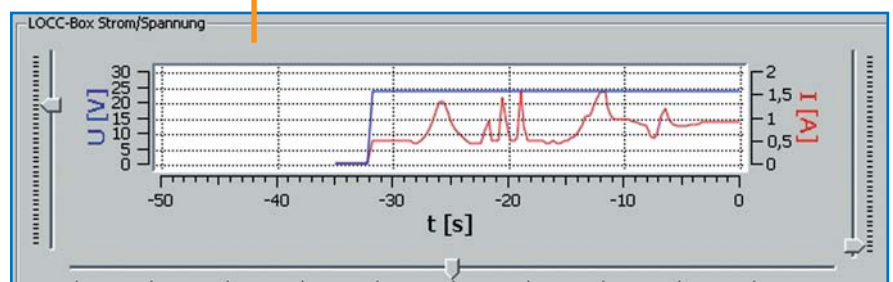

Plotter function for the selected module – current/voltage progression (analysis)

* in connection with a gateway (CANopen, EtherCAT, Profinet-IO, Profibus-DP)

Intelligent current monitoring management system: LCOS-C

Flammability class
UL 94-V0

Bus coupler for all
conventional systems

Adjustable characteristics

Adjustable rated current

Manual On /Off

2-channel design

2-pole disconnection

"Power ON" effect

Saving of the last status

**Temperature-independent
response time**

Supply - also with
galvanic insulation

Clear labelling



and energy C



SkyBLUE

Intermediate in-feed option

Status output operation

failure, manual switch-off, 90 % capacity

Remote On/Off

**Modular expandable
data bus**

**Modular expandable
power bus**

**Integrated protection
against alignment**

**UL508,
GL approvals**

**Plug-in functional
assemblies**

Load monitoring · LCOS-CC

Electronic load monitoring up to DC 10 A

2-channel version, single pole switching, DC 1 A – DC 10 A, characteristic can be set

Collective fault message: single/collective/90% message, Remote Control input



Dimensions

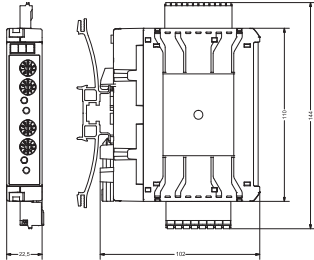

PIN assignment

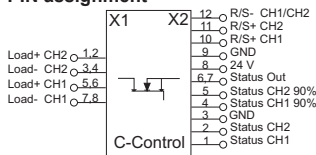

Description	Part-No.	Type	PU	
Screw terminal				
Nominal voltage	DC 24 V	779000.2111	LCOS-CC-2K-1P DC 24V	1
Push-In				
Nominal voltage	DC 24 V	779100.2111	LCOS-CC-2K-1P DC 24V	1
Note				
Included in the delivery	Plug-in terminals : RM5.08 and RM 3.50			
Not included in the delivery	Function carrier and other accessories, see „accessories“			
Input				
Nominal voltage	DC 24 V			
Operation voltage range	DC 20.4 V – 28.8 V			
Rated current	DC 10 A			
Supply current	DC 32 A via LCOS power bus			
Reverse voltage protection	internal electronics			
Control input (Set / Reset)				
Signal level	DC 24 V (EN 61131)			
OFF	Pulse with falling edge >100 ms, <800 ms			
ON	Pulse with falling edge > 1 s			
Galvanic insulation I/O	2.5 kV, 50 Hz, 1 min.			
Output				
Switching element	MosFet			
Output current	max. DC 10 A			
Voltage drop	<170 mV (10 A)			
Status Indication	LED green: operating voltage ON, no fault, green flashing: 90 % I _B red flashing: triggered, red: OFF			
Switch-on capacity	>10000 µF			
Current range	1 A – 10 A (adjustable via switch in 1 A steps)			
Characteristic	fast (1), medium (2), slow 1 (3), slow 2 (4), slow 3 (5), adjustable via switch, see 'characteristic curves'			
Signal output				
Switching element	Transistor in open collector version with Pull Up resistance			
Single channel message	(Status CH1, CH2) Acc. to IEC 61131-2: High level, no errors, low level, there are errors			
90 % of the rated current I _B	(Status 90 % CH1, CH2) Acc. to IEC 61131-2: High level <90 %, low level >90 %			
Insulation voltage	–			
centralised fault signalling	(Status Out) Single channel message 1+2, decoupled via diodes			
General				
Housing material	PA 6.6 (UL 94-V0; NFF I2, F2)			
Field installation	can be connected to LCOS function carrier 22.5 mm (accessories), DIN Rail mounting EN 60715			
Protection class	IP 20			
Installation position	Optional			
Vibration resistance	Vibration: EN 60068-2-6 Fc, Shock: EN 60068-2-27 Ea			
Climatic conditions	Acc. to EN 60721 Stationary use at weather protected locations			
Termination	X1: Load side: 8-pole measuring strip, CS 5,08 X2: Control side: 12-pole measuring strip, CS 3,5			
Operation temperature range	0 °C – 55 °C			
Storage temperature range	-40 – 70 °C			
Dimensions (w × h × d)	22.5 × 110.0 × 102.0 mm (including function carrier, without plug-in terminals on the side)			
Weight (kg/piece)	0.200			
Approvals	CE, UL601010UL2367			
Standards	EN 61131-2, EN 55016-1-2, EN 60529, EN 61000-6-2, EN 61000-6-4			

Load monitoring · LCOS-CC

Electronic load monitoring up to DC 10 A

1-channel version, two-pole switching, DC 1 A – DC 10 A can be set, characteristic can be set

Collective fault message: single/collective/90% message, Remote Control input per channel



Dimensions

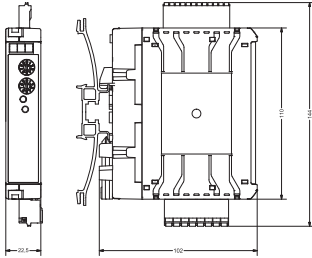

PIN assignment

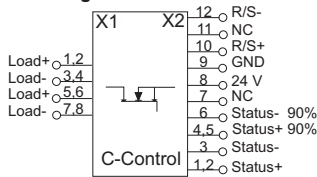

Description	Part-No.	Type	PU	
Screw terminal				
Nominal voltage	DC 24 V	779000.1211	LCOS-CC-1K-2P DC 24V	1
Push-In				
Nominal voltage	DC 24 V	779100.1211	LCOS-CC-1K-2P DC 24V	1
Note				
Included in the delivery	Plug-in terminals : RM5.08 and RM 3.50			
Not included in the delivery	Function carrier and other accessories, see „accessories“			
Input				
Nominal voltage	DC 24 V			
Operation voltage range	DC 20.4 – 28.8 V			
Rated current	DC 10 A			
Supply current	DC 32 A via LCOS power bus			
Reverse voltage protection	internal electronics			
Control input (Set / Reset)				
Signal level	DC 24 V (EN 61131)			
OFF	Pulse with falling edge >100 ms, <800 ms			
ON	Pulse with falling edge > 1 s			
Galvanic insulation I/O	2.5 kV, 50 Hz, 1 min.			
Output				
Switching element	MosFet and relay (galvanic separation both poles: 500 V)			
Output current	max. DC 10 A			
Voltage drop	<170 mV (10 A)			
Status Indication	LED green: operating voltage ON, no fault, green flashing: 90 % I _B red flashing: triggered, red: OFF			
Switch-on capacity	>10000 µF			
Current range	1 A – 10 A (adjustable via switch in 1 A steps)			
Characteristic	fast (1), medium (2), slow 1 (3), slow 2 (4), slow 3 (5), adjustable via switch, see 'characteristic curves'			
Signal output				
Switching element	One relay with 1 S per signal type			
Single channel message	(Status CH1, CH2) 1 N/O contact, AC/DC 250 V, 1 A Relay closed: error Relay open: no error			
90 % of the rated current I _B	(Status 90 % CH1, CH2) 1 N/O contact, AC/DC 250 V, 1 A Relay closed: >90 %, Relay open: <90 %			
Insulation voltage	2.5 kV, 50 Hz, 1 min.			
centralised fault signalling	-			
General				
Housing material	PA 6.6 (UL 94-V0; NFF I2, F2)			
Field installation	can be connected to LCOS function carrier 22.5 mm (accessories), DIN Rail mounting EN 60715			
Protection class	IP 20			
Installation position	Optional			
Vibration resistance	Vibration: EN 60068-2-6 Fc, Shock: EN 60068-2-27 Ea			
Climatic conditions	Acc. to EN 60721 Stationary use at weather protected locations			
Termination	X1: Load side: 8-pole measuring strip, CS 5,08 X2: Control side: 12-pole measuring strip, CS 3,5			
Operation temperature range	0 °C – 55 °C			
Storage temperature range	-40 – 70 °C			
Dimensions (w × h × d)	22.5 × 110.0 × 102.0 mm (including function carrier, without plug-in terminals on the side)			
Weight (kg/piece)	0.200			
Approvals	CE, UL601010UL2367			
Standards	EN 61131-2, EN 55016-1-2, EN 60529, EN 61000-6-2, EN 61000-6-4			

Modular housing system · LCOS Accessories

Carrier base: 22,5 mm

Data bus 12-pole power bus AC/DC 500 V, 4×16 A

Integrated PE contact

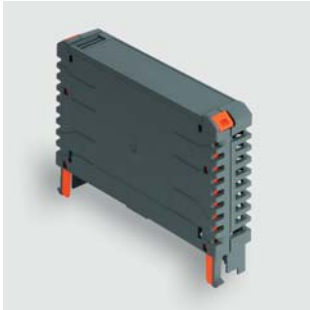

Description	Part-No.	Type	PU
Description	780100.225.1	LCOS-FGO-225-00/00/00-1	1
Function housing 22.5 mm, with cooling slits, closed front plate, no connection opening top/bottom	780100.225.2	LCOS-FGO-225-00/00/00-1	10
Function housing 22.5 mm, with cooling slits, closed front plate, connection opening top/bottom	780103.225.1	LCOS-FGO-225-01/00/01-1	1
Function housing 22.5 mm, with cooling slits, closed front plate, connection opening top/bottom	780103.225.2	LCOS-FGO-225-01/00/01-1	10
Function carrier 22.5 mm, cannot be expanded with modules, no PE direct contact	780200.225.1	LCOS-FT-NC-225-00-00-1	1
Function carrier 22.5 mm, cannot be expanded with modules, no PE direct contact	780200.225.2	LCOS-FT-NC-225-00-00-1	10
Function carrier 22.5 mm, cannot be expanded with modules, with PE direct contact	780201.225.1	LCOS-FT-PE-225-00-00-1	1
Function carrier 22.5 mm, cannot be expanded with modules, with PE direct contact	780201.225.2	LCOS-FT-PE-225-00-00-1	10
Function carrier 22.5 mm, can be expanded with modules, with PE direct contact	780331.225.1	LCOS-FT-PE-225-00-03-1	1
Function carrier 22.5 mm, can be expanded with modules, with PE direct contact	780331.225.2	LCOS-FT-PE-225-00-03-1	10
Function carrier 22.5 mm, can be expanded with modules, with PE direct contact, power module	780402.225.1	LCOS-FT-PE-225-0P-02-1	1
Function carrier 22.5 mm, can be expanded with modules, with PE direct contact, power module	780402.225.2	LCOS-FT-PE-225-0P-02-1	10
Function carrier 22.5 mm, can be expanded with modules, with PE direct contact, data and power module	780403.225.1	LCOS-FT-PE-225-DP-03-1	1
Function carrier 22.5 mm, can be expanded with modules, with PE direct contact, data and power module	780403.225.2	LCOS-FT-PE-225-DP-03-1	10

Modular housing system - LCOS Accessories

Carrier base: 35 mm

Data bus 12-pole power bus AC/DC 500 V, 4×16 A

Integrated PE contact



Description	Part-No.	Type	PU
Function housing 35 mm, with cooling slits, closed front plate, no connection opening top/bottom	780100.350.1	LCOS-FGO-350-00/00/00-1	1
Function housing 35 mm, with cooling slits, closed front plate, no connection opening top/bottom	780100.350.2	LCOS-FGO-350-00/00/00-1	10
Function housing 35 mm, with cooling slits, closed front plate, connection opening top/bottom	780103.350.1	LCOS-FGO-350-01/00/01-1	1
Function housing 35 mm, with cooling slits, closed front plate, connection opening top/bottom	780103.350.2	LCOS-FGO-350-01/00/01-1	10
Function carrier 35 mm, cannot be expanded with modules, no PE direct contact	780200.350.1	LCOS-FT-NC-350-00-00-1	1
Function carrier 35 mm, cannot be expanded with modules, no PE direct contact	780200.350.2	LCOS-FT-NC-350-00-00-1	10
Function carrier 35 mm, cannot be expanded with modules, no PE direct contact	780201.350.1	LCOS-FT-PE-350-00-00-1	1
Function carrier 35 mm, cannot be expanded with modules, no PE direct contact	780201.350.2	LCOS-FT-PE-350-00-00-1	10
Function carrier 35 mm, can be expanded with modules, with PE direct contact	780331.350.1	LCOS-FT-PE-350-00-03-1	1
Function carrier 35 mm, can be expanded with modules, with PE direct contact	780331.350.2	LCOS-FT-PE-350-00-03-1	10
Function carrier 35 mm, can be expanded with modules, with PE direct contact, power module	780402.350.1	LCOS-FT-PE-350-0P-02-1	1
Function carrier 35 mm, can be expanded with modules, with PE direct contact, power module	780402.350.2	LCOS-FT-PE-350-0P-02-1	10
Function carrier 35 mm, can be expanded with modules, with PE direct contact, data and power module	780403.350.1	LCOS-FT-PE-350-DP-03-1	1
Function carrier 35 mm, can be expanded with modules, with PE direct contact, data and power module	780403.350.2	LCOS-FT-PE-350-DP-03-1	10

Modular housing system · LCOS Accessories

Supply Carrier base: 57,5 mm, 70 mm
 Data bus 12-pole power bus AC/DC 500 V, 4×16 A
 Integrated PE contact



Description	Part-No.	Type	PU
Function carrier 57.5 mm, with supply DC 24 V, no FBS, with PE direct contact, ready for connection	780700.575.1	LCOS-FTE-PE-575-NC-00-1	1
Function carrier 70 mm, with supply DC 24 V, no FBS, with PE direct contact, ready for connection	780700.700.1	LCOS-FTE-PE-700-NC-00-1	1
Function carrier 57.5 mm, with supply AC 240 V, no FBS, with PE direct contact, ready for connection	780701.575.1	LCOS-FTE-PE-575-NC-01-1	1
Function carrier 70 mm, with supply AC 240 V, no FBS, with PE direct contact, ready for connection	780701.700.1	LCOS-FTE-PE-700-NC-01-1	1
Function carrier 57.5 mm, with supply 3-phase AC 500 V, no FBS, with PE direct contact, ready for connection	780702.575.1	LCOS-FTE-PE-575-NC-02-1	1
Function carrier 70 mm, with supply 3-phase AC 500 V, no FBS, with PE direct contact, ready for connection	780702.700.1	LCOS-FTE-PE-700-NC-02-1	1

Modular housing system - LCOS Accessories

Accessories

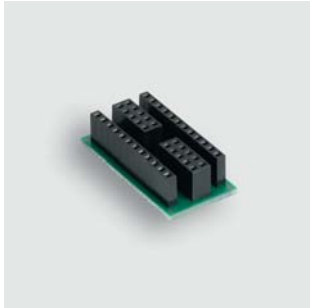

Description	Part-No.	Type	PU
Replace front plate, closed, function housing 22.5 mm	780600.225.3	LCOS-ZB-FPL-225-00-1	50
Replace front plate, closed, function housing 22.5 mm	780600.225.4	LCOS-ZB-FPL-225-00-1	100
Replace front plate, closed, function housing 35 mm	780600.350.3	LCOS-ZB-FPL-350-00-1	50
Replace front plate, closed, function housing 35 mm	780600.350.4	LCOS-ZB-FPL-350-00-1	100
Data module 22.5 mm	780900.225.2	LCOS-ZB-DM-225-12-00-1	10
Data module 22.5 mm	780900.225.3	LCOS-ZB-DM-225-12-00-1	50
Data module 35 mm	780900.350.2	LCOS-ZB-DM-350-12-00-1	10
Data module 35 mm	780900.350.3	LCOS-ZB-DM-350-12-00-1	50
Power module 22.5 mm	780910.225.2	LCOS-ZB-PM-225-00-1	10
Power module 22.5 mm	780910.225.3	LCOS-ZB-PM-225-00-1	50
Power module 35 mm	780910.350.2	LCOS-ZB-PM-350-00-1	10
Power module 35 mm	780910.350.3	LCOS-ZB-PM-350-00-1	50
Attachment screws data/power module	780991.000.4	LCOS-ZB-Schraube-00	100
Coding pins	780990.000.3	LCOS-ZB-Codier	50
Data bridge 12-pole, insulated	780960.012.2	LCOS-ZB-DB-12-00	10
Data bridge 12-pole, insulated	780960.012.3	LCOS-ZB-DB-12-00	50
Power bridge 1-pole, insulated	780961.001.2	LCOS-ZB-PB	10
Power bridge 1-pole, insulated	780961.001.3	LCOS-ZB-PB	50
PCB contact Power and PE, 10 A, 1-pole	780962.000.4	LCOS-ZB-LPK-00	100
PCB contact Power and PE, 10 A, 1-pole	780962.000.5	LCOS-ZB-LPK-00	500
PCB contact Power and PE, 10 A, 1-pole	780962.000.6	LCOS-ZB-LPK-00	1000
Labelling plates 5x5 mm, white, frame with 200 plates	780981.000.2	LCOS-ZB-BZS-white-00	10
Labelling plates 5x5 mm, red, frame with 200 plates	780982.000.2	LCOS-ZB-BZS-red-00	10
Labelling plates 5x5 mm, blue, frame with 200 plates	780983.000.2	LCOS-ZB-BZS-blue-00	10
Terminal black, CS 5.08, 8-pole, 2.5 mm ² Push-in, 1-8 printed	780922.000.2	LCOS-ZB_KL_FS-508-25-8-black	10
Terminal black, CS 3.50, 12-pole, 1.5 mm ² Push-in, 1-12 printed	780921.000.2	LCOS-ZB-KL_FS-350-15-12-black	10
Laboratory printed circuit board (PCB) FR4, 1.5 mm	780963.000.2	LCOS-ZB-EB-00-L	10

LOCC-Box • Characteristic Curves

All LOCC-Box devices have the same characteristic curves

1-10 A (6A)

Switch position 1: Characteristic fast

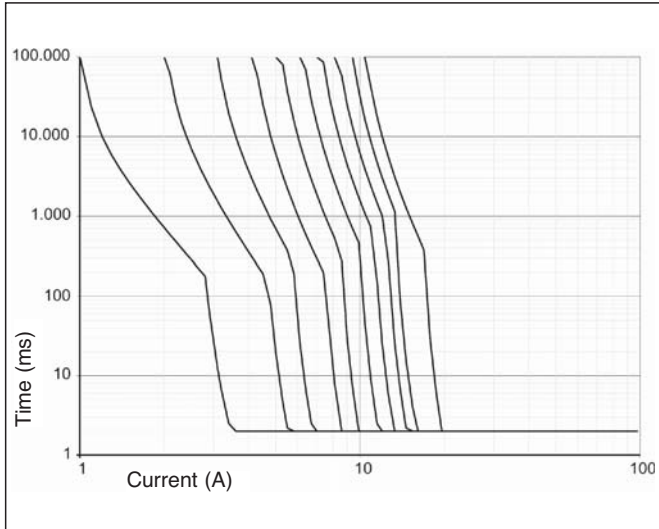

Switch position 2: Characteristic medium

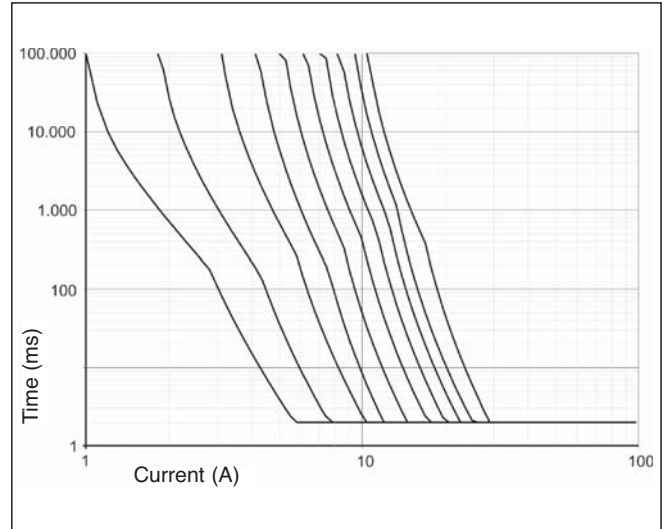

Switch position 3: Characteristic slow-1

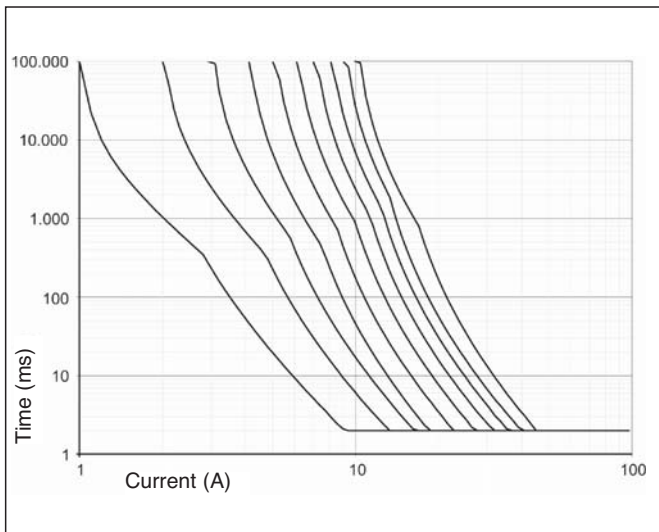

Switch position 4: Characteristic slow-2

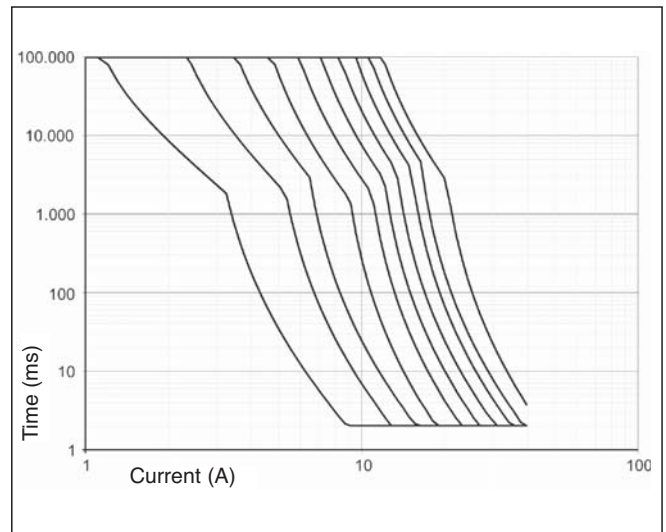

Switch position 5: Characteristic slow-3

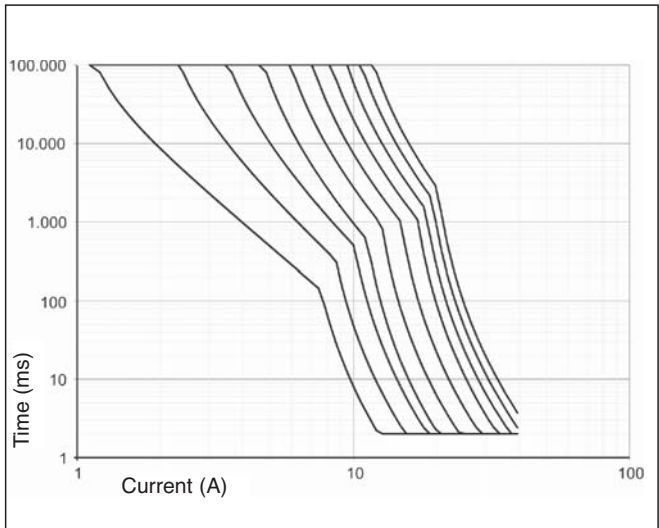

LOCC-Box • Characteristic Curves

Characteristic Curves 0-2 A

Switch position 1: Characteristic fast

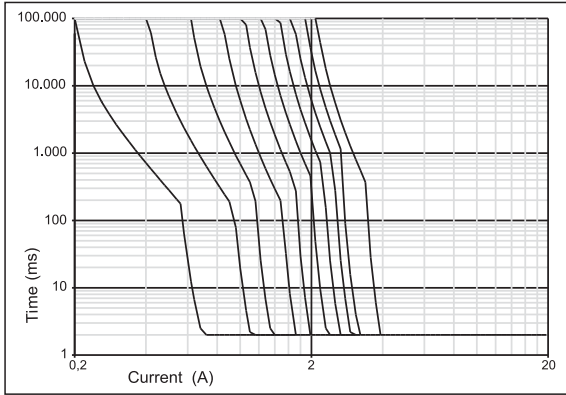

Switch position 2: Characteristic medium

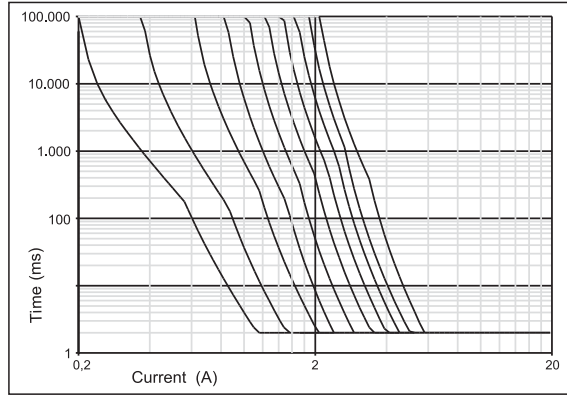

Switch position 3: Characteristic slow

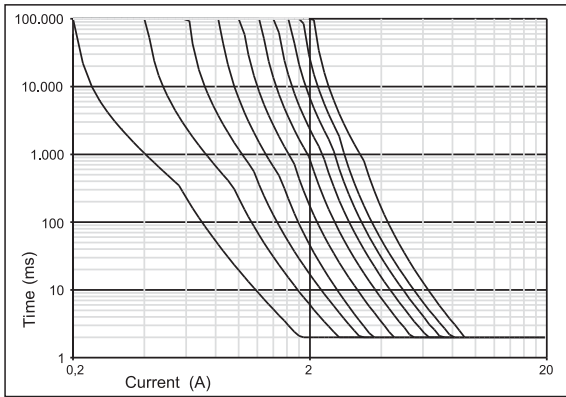

Characteristic Curves for the NEC Class 2 device

Switch position 1: Characteristic fast

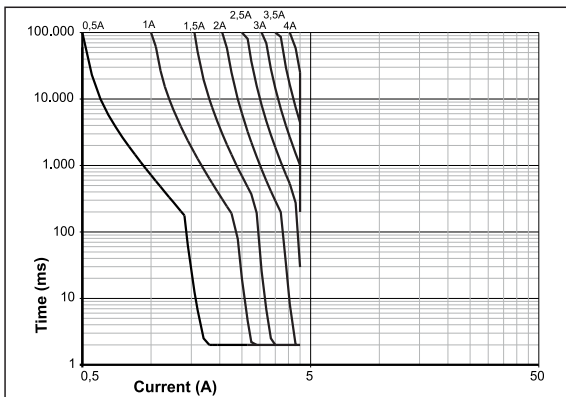

Switch position 2: Characteristic medium

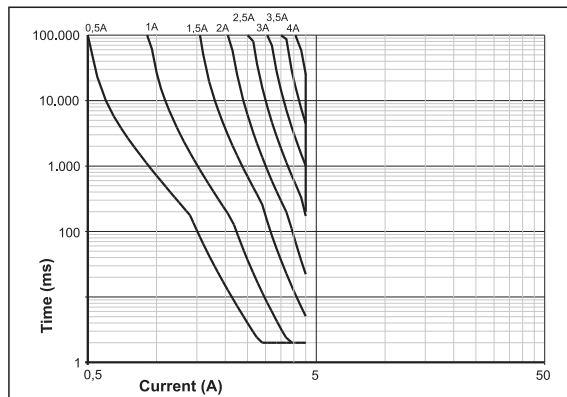

Switch position 3: Characteristic slow

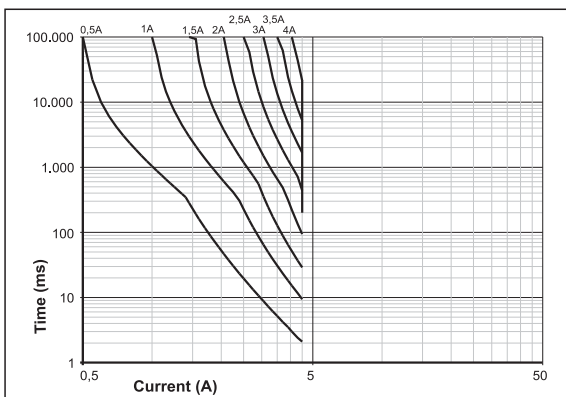

Part number Index

Part-No.	Page	Part-No.	Page	Part-No.	Page	Part-No.	Page	Part-No.	Page	Part-No.	Page
716400	12	780701.575.1	42								
716401	12	780701.700.1	42								
716401.0050	12	780702.575.1	42								
716403	19	780702.700.1	42								
716404	19	780900.225.2	43								
716406	14	780900.225.3	43								
716407.xxxx	15	780900.350.2	43								
716408	17	780900.350.3	43								
716409	13	780910.225.2	43								
716410	20	780910.225.3	43								
716410.0050	20	780910.350.2	43								
716411	21	780910.350.3	43								
716412.xxxx	16	780921.000.2	43								
716413	18	780922.000.2	43								
716414	23	780960.012.2	43								
716418	22	780960.012.3	43								
716420	33	780961.001.2	43								
716421	31	780961.001.3	43								
716425	28	780962.000.4	43								
716435	29	780962.000.5	43								
716436	30	780962.000.6	43								
716437	34	780963.000.2	43								
716447	32	780981.000.2	43								
716456	27	780982.000.2	43								
716457	25	780983.000.2	43								
716458	26	780990.000.3	43								
716459	24	780991.000.4	43								
779000.1211	39										
779000.2111	38										
779100.1211	39										
779100.2111	38										
780100.225.1	40										
780100.225.2	40										
780100.350.1	41										
780100.350.2	41										
780103.225.1	40										
780103.225.2	40										
780103.350.1	41										
780103.350.2	41										
780200.225.1	40										
780200.225.2	40										
780200.350.1	41										
780200.350.2	41										
780201.225.1	40										
780201.225.2	40										
780201.350.1	41										
780201.350.2	41										
780331.225.1	40										
780331.225.2	40										
780331.350.1	41										
780331.350.2	41										
780402.225.1	40										
780402.225.2	40										
780402.350.1	41										
780402.350.2	41										
780403.225.1	40										
780403.225.2	40										
780403.350.1	41										
780403.350.2	41										
780600.225.3	43										
780600.225.4	43										
780600.350.3	43										
780600.350.4	43										
780700.575.1	42										
780700.700.1	42										

Copyright

Protected trademarks and trade names are not always labelled as such in this publication. This does not mean they are free names as defined in the trademark and brand mark law. Publication does not imply that the descriptions or pictures used are free from rights of third parties. The information is published without regard to possible patent protection. Trade names are used without any guarantee that they can be used freely. In putting together text, pictures and data, we proceeded with the greatest care. Despite this, the possibility of errors cannot be completely excluded. We therefore reject any legal responsibility or liability. We are, of course, grateful for any recommendations for improvement or information useful for making corrections or establishing the truth. But the author does not assume any responsibility for the content of these documents.



RoHS

USA
 LUTZE INC.
 13330 South Ridge Drive
 Charlotte, NC 28273
 Tel.: +1 704 504-0222
 Fax: +1 704 504-0223
 info@lutze.com



Cables

Cable assemblies

Cable fittings

LSC Wiring System

Module and Interface Technology

Ethernet Connectivity

Suppression Technology

Power Supplies

Railway Technology

Germany

Friedrich Lütze GmbH
 Postfach 12 24 (PLZ 71366)
 Bruckwiesenstrasse 17-19
 D-71384 Weinstadt
 Tel.: +49 7151 6053-0
 Fax: +49 7151 6053-277(-288)
 info@luetze.de

United Kingdom

LÜTZE Ltd.
 Unit 3 Sandy Hill Park
 Sandy Way, Amington
 Tamworth, Staffs, B77 4DU
 Tel.: +44 1827 31333-0
 Fax: +44 1827 31333-2
 sales.gb@lutze.co.uk

Austria

LÜTZE Elektrotechnische
 Erzeugnisse Ges.m.b.H.
 office@luetze.at

Switzerland

LÜTZE AG
 info@luetze.ch

France

LUTZE SAS
 lutze@lutze.fr

Spain

LUTZE, S.L.
 info@lutze.es

China

Luetze Trading (Shanghai) Co.Ltd.
 info@luetze.cn

